

# SHARP

SPEC No.	E L 0 7 Z 0 4 1 A
I S S U E:	Jan. 23 1996

To: \_\_\_\_\_

REQUEST FOR  
CONFIRMATION

## S P E C I F I C A T I O N S

Product Type Single chip drive IC (270K/320K pixels B/W CCD)

Model No. L Z 9 G G 3 3 M

※This specifications contains 58 pages including the cover and appendix.  
If you have any objections, please contact us before issuing purchasing order.

CUSTOMERS ACCEPTANCE

DATE: \_\_\_\_\_

BY: \_\_\_\_\_

PRESENTED

BY: *Y. Kusano*

Y. KUSANO  
Dept. General Manager

REVIEWED BY:

PREPARED BY:

*A. Tokemoto*

*S. Inoue*

Engineering Dept. 3  
Logic IC Engineering Center  
Tenri Integrated Circuits Group  
SHARP CORPORATION

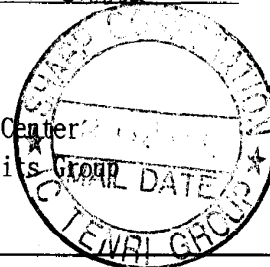

- Handle this document carefully for it contains material protected by international copyright law. Any reproduction, full or in part, of this material is prohibited without the express written permission of the company.
- When using the products covered herein, please observe the conditions written herein and the precautions outlined in the following paragraphs. In no event shall the company be liable for any damages resulting from failure to strictly adhere to these conditions and precautions.
  - (1) The products covered herein are designed and manufactured for the following application areas. When using the products covered herein for the equipment listed in Paragraph (2), even for the following application areas, be sure to observe the precautions given in Paragraph (2). Never use the products for the equipment listed in Paragraph (3).
    - Office electronics
    - Instrumentation and measuring equipment
    - Machine tools
    - Audiovisual equipment
    - Home appliances
    - Communication equipment other than for trunk lines
  - (2) Those contemplating using the products covered herein for the following equipment which demands high reliability, should first contact a sales representative of the company and then accept responsibility for incorporating into the design fail-safe operation, redundancy, and other appropriate measures for ensuring reliability and safety of the equipment and the overall system.
    - Control and safety devices for airplanes, trains, automobiles, and other transportation equipment
    - Mainframe computers
    - Traffic control systems
    - Gas leak detectors and automatic cutoff devices
    - Rescue and security equipment
    - Other safety devices and safety equipment, etc.
  - (3) Do not use the products covered herein for the following equipment which demands extremely high performance in terms of functionality, reliability, or accuracy.
    - Aerospace equipment
    - Communications equipment for trunk lines
    - Control equipment for the nuclear power industry
    - Medical equipment related to life support, etc.
  - (4) Please direct all queries and comments regarding the interpretation of the above three Paragraphs to a sales representative of the company.
- Please direct all queries regarding the products covered herein to a sales representative of the company.

## CONTENTS

1. General	.....	P. 2
1-1. Features		
1-2. Functions		
2. Pin Assignment	.....	P. 3
3. Block Diagram	.....	P. 4
4. Pin Description	.....	P. 5
4-1. Pin description		
4-2. Supplementary explanation		
5. Electrical Characteristics	.....	P. 10
5-1. Absolute Maximum Ratings		
5-2. DC Characteristics		
6. Pulse Timing	.....	P. 11
6-1. Synchronizing vertical pulse		
6-2. Vertical pulse dor driving CCD		
6-3. Synchronizing horizontal pulse		
6-4. Horizontal pulse for driving CCD		
6-5. Read out pulse		
6-6. Non-interlace mode		
7. Package Outline	.....	P. 53

## 1. General

The LZ9GG33M is a CMOS gate array LSI. It generates timing pulses for driving a CCD area sensor which has 270,000 or 320,000 pixels, synchronous pulse for TV signals and processing for video signals.

### 1-1. Features

- \* The package material is plastic.
- \* A p-type silicon circuit board is used.
- \* The package type is 48-pin QFP (0.5mm pin-pitch).
- \* The process (structure) is CMOS.
- \* The delay time per 1 gate is 0.9ns.
- \* Not designed or rated as radiation hardened.

### 1-2. Functions

- \* Designed for CCD monochrome area sensor with 270,000 or 320,000 pixels.
- \* Switchable between EIA and CCIR mode.
- \* Single +5V power supply.
- \* Electronic shutter and EE control is possible.
- \* Mirror image control function is possible.
- \* Four-power supply operation CCD mode (TypeA, TypeB) and Two-power supply operation CCD mode is possible.
- \* Field accumulation mode and Frame accumulation mode is possible in the Four-power supply operation CCD.
- \* To select the following max. shutter speed is possible in the Two-power supply operation CCD.  
about 1/100,000s , 1/56,000s , 1/32,000s and 1/11,000s

## 2. Pin Assignment

PIN NO.	I/O	SIGNAL	PIN NO.	I/O	SIGNAL
1	ICD	TST1	25	ICD	TST6
2	ICD	TST2	26	ICU	CCD1
3	ICSU	VRI	27	ICU	CCD2
4	ICU	TVMD	28	O6MA2	V1X
5	O	CSYN	29	O6MA2	V2X
6	-	VDD	30	-	VDD
7	-	GND	31	-	GND
8	O	CBLK	32	O6MA2	V3X
9	O	HD	33	O6MA2	V4X
10	O	VDD	34	O	VH1X
11	O	HBLK	35	O	OFDX
12	ICD	TST3	36	O	VH3X
13	O	BCP	37	ICU	ITCH
14	ICD	TST4	38	ICU	EEST
15	ICD	TST5	39	ON	WIND
16	ICU	PHCH	40	O6MA3	FR
17	ICU	ACLX	41	O6MA2	FH2B
18	ICU	MIR	42	O6MA3	FH2
19	ICU	FLMD	43	-	GND
20	ICU	EEMD	44	O6MA3	FH1
21	IC	EEUD	45	O6MA2	FH1B
22	IC	EENR	46	OSCI	OSCI
23	O6MA2	FCDS	47	OSCO	OSCO
24	O6MA2	FS	48	ICD	NINT





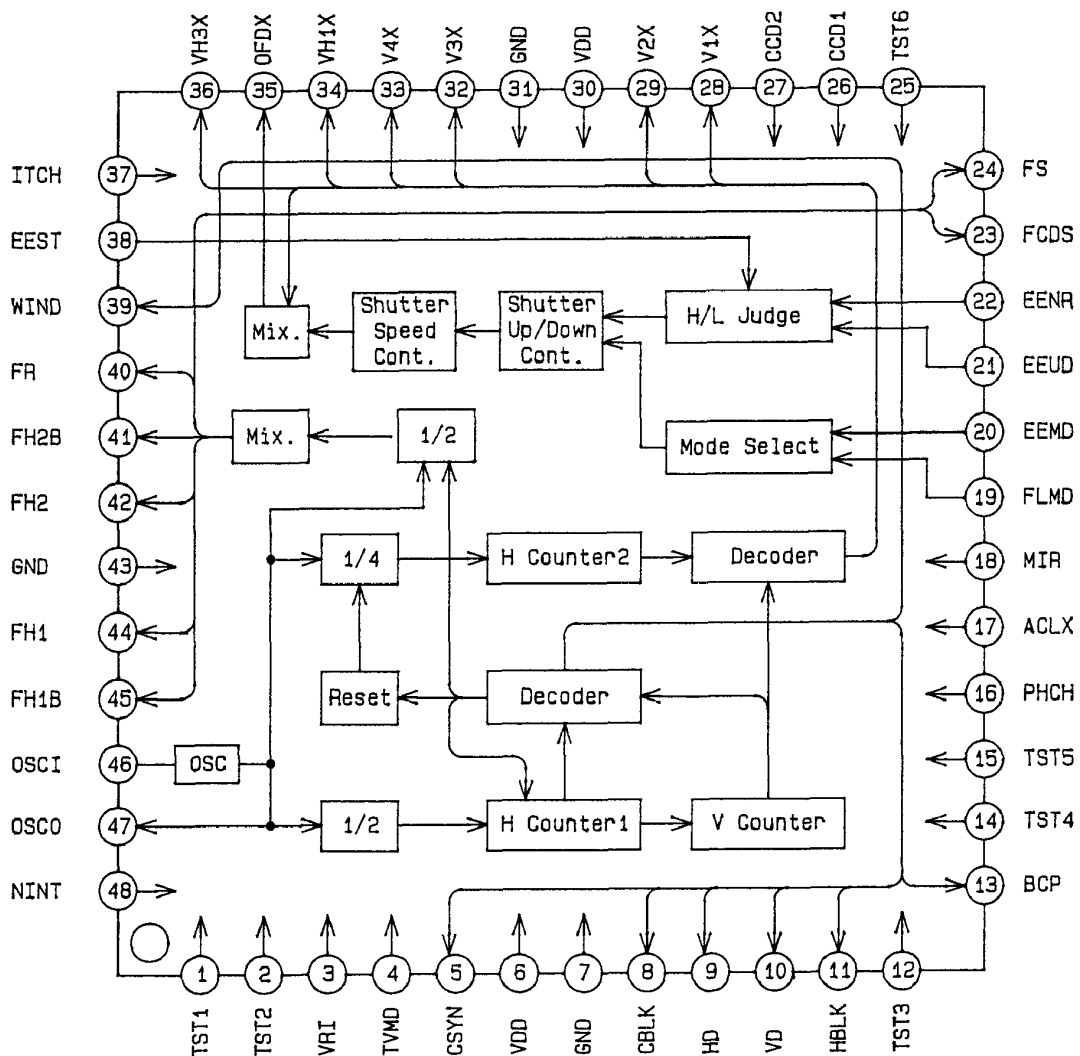

IC : Input (CMOS level)  
 ICU : Input (CMOS level with pull-up resistor)  
 IC SU : Input (CMOS schmitt-trigger level with pull-up resistor)  
 ICD : Input (CMOS level with pull-down resistor)  
 O : Output  
 O6MA2 : Output  
 O6MA3 : Output  
 ON : Output(N-ch open drain)  
 OSCI : Input pin for oscillation  
 OSCO : Output pin for oscillation

### 3. Block Diagram



## 4. Pin Description

## 4-1. Pin description

No.	Symbol	I/O	Pol.	Pin Name	Description
1	TST1	ICD	-	Test terminal 1	A test pin. Set open or to L level in the normal mode.
2	TET2	ICD	-	Test terminal 2	A test pin. Set open or to L level in the normal mode.
3	VRI	ICSU	-	Vertical reset input	An input pin for resetting internal Ver. counter. The input pulse is VSYNC. (negative Polarity)
4	TVMD	ICU	-	TV mode select	An input pin to select TV standards. L level ; NTSC mode H level or open : PAL mode
5	CSYN	0		Composite synchronizing pulse	Composite sync. signal output pin.
6	VDD	-	-	Power supply	Supply +5 V power.
7	GND	-	-	Ground	A grounding pin.
8	CBLK	0		Composite blanking pulse	Composite blanking pulse.
9	HD	0		Hor. drive pulse	The pulse occurs at the start of lines.
10	VD	0		Ver. drive pulse	The pulse occurs at the start of every fields.
11	HBLK	0		Hor. blanking pulse	A pulse that correspondes to the cease period of the Hor. transfer pulse.
12	TST3	ICD	-	Test terminal 3	A test pin. Set open or to L level in the normal mode.
13	BCP	0		Optical black clamp pulse	A pulse to clamp the optical black signal. This pulse stays low during the absence of effective pixels within the ver. blanking.
14	TST4	ICD	-	Test terminal 4	A test pin. Set open or to L level in the normal mode.
15	TST5	ICD	-	Test terminal 5	A test pin. Set open or to L level in the normal mode.
16	PHCH	ICU	-	Hor. drive pulse control input	An inout pin to control Hor. drive pulses FH1 (pin 44), FH1B(pin 45), FH2(pin42) and FH2B(pin41). H level or open : continuous pulse L level : discontinuous pulse
17	ACLX	ICU	-	All clear input	An input pin for resetting all internal circuit at power on.

LZ9GG33M

No.	Symbol	I/O	Pol.	Pin Name	Description																				
18	MIR	ICU	-	Mirror mode select	An input pin to select Mirror mode or Normal mode. L level : Normal drive mode H level or open : Mirror drive mode <table border="1"> <tr> <td>MIR</td> <td>L (Normal mode)</td> <td>H or open (Mirror mode)</td> </tr> <tr> <td>FH1B</td> <td>≠FH1</td> <td>≠FH2</td> </tr> <tr> <td>FH2B</td> <td>≠FH2</td> <td>≠FH1</td> </tr> </table>	MIR	L (Normal mode)	H or open (Mirror mode)	FH1B	≠FH1	≠FH2	FH2B	≠FH2	≠FH1											
MIR	L (Normal mode)	H or open (Mirror mode)																							
FH1B	≠FH1	≠FH2																							
FH2B	≠FH2	≠FH1																							
19	FLMD	ICU	-	Electronic Exposure and WIND pulse control 1	An input pin to control Electronic Exposure mode, Flickerless mode and WIND(pin39) pulse output. <table border="1"> <tr> <td>EEMD</td> <td>FLMD</td> <td>Electronic Shutter mode</td> <td>WIND</td> </tr> <tr> <td>L</td> <td>L</td> <td>1/ 60s (CCIR:1/ 50s)</td> <td>WIND1</td> </tr> <tr> <td>L</td> <td>H</td> <td>1/100s (CCIR:1/120s)</td> <td>WIND1</td> </tr> <tr> <td>H</td> <td>L</td> <td>Electronic Exposure mode</td> <td>WIND1</td> </tr> <tr> <td>H</td> <td>H</td> <td>Electronic Exposure mode</td> <td>WIND2</td> </tr> </table>	EEMD	FLMD	Electronic Shutter mode	WIND	L	L	1/ 60s (CCIR:1/ 50s)	WIND1	L	H	1/100s (CCIR:1/120s)	WIND1	H	L	Electronic Exposure mode	WIND1	H	H	Electronic Exposure mode	WIND2
EEMD	FLMD	Electronic Shutter mode	WIND																						
L	L	1/ 60s (CCIR:1/ 50s)	WIND1																						
L	H	1/100s (CCIR:1/120s)	WIND1																						
H	L	Electronic Exposure mode	WIND1																						
H	H	Electronic Exposure mode	WIND2																						
20	EEMD	ICU	-	Electronic Exposure and WIND pulse control 2	WIND1:Vertical pulse WIND2:Composit pulse (Vertical and Horizontal)																				
21	EEUD	IC	-	Electronic Exposure control 1	An input pin to control Electronic Exposure. <table border="1"> <tr> <td>EEUD</td> <td>EENR</td> <td>Shutter speed</td> </tr> <tr> <td>H</td> <td>L</td> <td>up</td> </tr> <tr> <td>H</td> <td>H</td> <td>control stopped</td> </tr> <tr> <td>L</td> <td>H</td> <td>down</td> </tr> </table>	EEUD	EENR	Shutter speed	H	L	up	H	H	control stopped	L	H	down								
EEUD	EENR	Shutter speed																							
H	L	up																							
H	H	control stopped																							
L	H	down																							
22	EENR	IC	-	Electronic Exposure control 2																					
23	FCDS	06MA2		CDS pulse 1	A pulse to clamp the feed-through level from CCD.																				
24	FS	06MA2		CDS pulse 2	A pulse to sample-hold the signal from CCD.																				
25	TST6	ICD	-	Test terminal 6	A test pin. Set open or to L level in the normal mode.																				
26	CCD1	ICU	-	CCD select input	An input pin to select sensor type, accumulation mode and max. shutter speed, with using ITCH (pin 37). See 4-2-2.																				
27	CCD2	ICU	-																						
28	V1X	06MA2		Ver. transfer pulse 1	A vertical transfer pulse for CCD. 4-power CCD ; Connect to 1AX, 2AX pin of ver. driver IC.																				
29	V2X	06MA2		Ver. transfer pulse 1	2-power CCD ; connect to φV1, φV2 pin of CCD.																				
30	VDD	-	-	Power supply	Supply +5 V power.																				
31	GND	-	-	Ground	A grounding pin.																				
32	V3X	06MA2		Ver. transfer pulse 3	A vertical transfer pulse for CCD. 4-power CCD ; Connect to 3AX, 4AX pin of ver. driver IC.																				
33	V4X	06MA2		Ver. transfer pulse 4	2-power CCD ; Connect to φV3, φV4 pin of CCD.																				

\* 4-power CCD ; four-power supply operation CCD

\* 2-power CCD ; two-power supply operation CCD



No.	Symbol	I/O	Pol.	Pin Name	Description													
34	VH1X	0		Read out pulse	A pulse that transfers the charge of the photodiode to the vertical sift resister. 4-power CCD ; Connect to the 1BX pin of the Ver. driver. 2-power CCD ; Connect to the VTG pin of CCD through the invert and level sift circuit.													
35	OFDX	0		OFG pulse output	A pulse that sweeps the charge of the photodiode for electrical shutter. Conect to OFD of CCD through the invert, level shift and DC offset circuit. Held at H level at normal mode.													
36	VH3X	0		Read out pulse	A pulse that transfers the charge of the photodiode to the vertical siftresister. 4-power CCD ; Connect to the 3BX pin of the Ver. driver. 2-power CCD ; Not use.													
37	ITCH	ICU	--	Accumuration mode select	An input pin to select sensor type accumulation mode and max. shutter speed,with using CCD1 (pin 26) and CCD2 (pin 27).													
38	EEST	ICU	--	Electronic Exposure control 3	An input pin to control Electronic Exposure, with using EEUD(pin 21) and EENR(pin 22). L level : Electronic Exposure is stopped. H level or open : Electronic Exposure is operated													
39	WIND	ON		Window pulse	A pulse for window pulse. <table border="1" style="margin-left: 20px;"> <thead> <tr> <th>EEMD</th> <th>FLMD</th> <th>WIND</th> </tr> </thead> <tbody> <tr> <td>L</td> <td>L</td> <td rowspan="2">WIND1 (vertical pulse)</td> </tr> <tr> <td>L</td> <td>H</td> </tr> <tr> <td>H</td> <td>L</td> <td rowspan="2">WIND2 (composit pulse)</td> </tr> <tr> <td>H</td> <td>H</td> </tr> </tbody> </table> <p>WIND1 ; When conected to EEST(pin 38), the operation of Electronic Exposure can be stopped at the upper side of monitor. WIND2 ; A pulse that pick out the center of CCD output. At this time, set H level or open at EEST (pin 38). As the output circuit of WIND is N-ch open drain, connect to VDD with R(<math>\geq 47k\Omega</math>).</p>	EEMD	FLMD	WIND	L	L	WIND1 (vertical pulse)	L	H	H	L	WIND2 (composit pulse)	H	H
EEMD	FLMD	WIND																
L	L	WIND1 (vertical pulse)																
L	H																	
H	L	WIND2 (composit pulse)																
H	H																	

\* 4-power CCD ; four-power supply operation CCD

\* 2-power CCD ; two-power supply operation CCD

No.	Symbol	I/O	Pol.	Pin Name	Description									
40	FR	06MA3		Reset pulse	A reset pulse for CCD. Connect to $\phi R$ of CCD through the D.C. offset circuit.									
41	FH2B	06MA2		Hor. transfer pulse 2B	A horizontal transfer pulse for CCD. Connect to $\phi H2B$ of CCD.									
42	FH2	06MA3		Hor. transfer pulse 2	A horizontal transfer pulse for CCD. Connect to $\phi H2$ of CCD.									
43	GND	-	--	Ground	A grounding pin.									
44	FH1	06MA3		Hor. transfer pulse 1	A horizontal transfer pulse for CCD. Connect to $\phi H1$ of CCD.									
45	FH1B	06MA2		Hor. transfer pulse 1B	A horizontal transfer pulse for CCD. Connect to $\phi H1B$ of CCD.									
46	OSCI	OSCI	--	Clock input	An input pin for reference clock oscillation. Connect to OSCO(pin 47) with R. The frequencies are as follows : at EIA mode : 19.0699MHz (1212fH) at CCIR mode : 19.3125MHz (1236fH) fH=Hor. frequency									
47	OSCO	OSCO	--	Clock output	An output pin for reference clock oscillation. The output is the inverse OSCI(pin 46).									
48	NINT	ICD	-	Non-interlace select	An input pin to select non-interlace mode. L level : Interlace mode H level or open : Non-interlace mode Period of Field (at non-interlace mode) <table border="1" style="margin-left: 20px;"> <thead> <tr> <th>TV mode</th> <th>Field</th> <th>number of line</th> </tr> </thead> <tbody> <tr> <td>EIA</td> <td>ODD</td> <td>262H</td> </tr> <tr> <td>CCIR</td> <td>1st</td> <td>312H</td> </tr> </tbody> </table>	TV mode	Field	number of line	EIA	ODD	262H	CCIR	1st	312H
TV mode	Field	number of line												
EIA	ODD	262H												
CCIR	1st	312H												

4-2. Supplementary explanation

4-2-1. Shutter speed changes at Electronic Exposure control mode.

E I A			C C I R		
No.	Charge time	shutter speed	No.	Charge time	shutter speed
0	262H or 263H	$\approx 1/$ 60s	0	312H or 313H	$\approx 1/$ 50s
1	252H+a	1/ 62s	1	302H+ $\beta$	1/ 52s
•	(by 10H step)		•	(by 10H step)	
19	72H+a	1/ 220s	24	72H+ $\beta$	1/ 220s
•	(by 4H step)		•	(by 4H step)	
30	28H+a	1/ 555s	35	28H+ $\beta$	1/ 550s
•	(by 2H step)		•	(by 2H step)	
37	14H+a	1/ 1,100s	42	14H+ $\beta$	1/ 1,090s
•	(by 1H step)		•	(by 1H step)	
44	7H+a	1/ 2,140s	49	7H+ $\beta$	1/ 2,125s
•	(by 0.5H step)		•	(by 0.5H step)	
50	4H+a	1/ 3,610s	55	4H+ $\beta$	1/ 3,590s
•	(by 0.25H step)		•	(by 0.25H step)	
62	1H+a	1/ 11,570s	67	1H+ $\beta$	1/ 11,550s
•	(by 0.125H step)		•	(by 0.125H step)	
69	0.125H+a	1/ 32,450s	74	0.125H+ $\beta$	1/ 32,690s
70	0.280H	1/ 56,090s	75	0.275H	1/ 56,800s
71	0.155H	1/101,430s	76	0.152H	1/102,720s

a=0.360H

$\beta$ =0.353H

4-2-2. Select sensor type, accumulation mode, max. shutter speed.

CCD 1 pin 26	CCD 2 pin 27	ITCH pin 37	CCD type		accumulation mode	max. shutter speed(s)			
						No.	EIA	No.	CCIR
L	L	L	4 power CCD	A	Frame	71	$\approx 1/101,430$	76	$\approx 1/102,720$
L	L	H	4 power CCD	A	Field	71	$\approx 1/101,430$	76	$\approx 1/102,720$
H	L	L	4 power CCD	B	Frame	71	$\approx 1/101,430$	76	$\approx 1/102,720$
H	L	H	4 power CCD	B	Field	71	$\approx 1/101,430$	76	$\approx 1/102,720$
L	H	L	2 power CCD	-	Field	71	$\approx 1/101,430$	76	$\approx 1/102,720$
L	H	H	2 power CCD	-	Field	69	$\approx 1/ 32,450$	74	$\approx 1/ 32,690$
H	H	L	2 power CCD	-	Field	70	$\approx 1/ 56,090$	75	$\approx 1/ 56,800$
H	H	H	2 power CCD	-	Field	62	$\approx 1/ 11,570$	67	$\approx 1/ 11,550$

4 power CCD A type ; LZ2314J/LZ2324J, LZ23142J/LZ23242J

4 power CCD B type ; LZ2314HJ/LZ2324HJ, LZ2414AJ/LZ2424AJ

2 power CCD ; LZ2316J/LZ2326J

\* 4-power CCD ; four-power supply operation CCD

\* 2-power CCD ; two-power supply operation CCD

## 5. Electorical Characteristics

## 5-1. Absolute Maximum Ratings

Parameter	Symbol	Rating	Unit
Supply voltage	$V_{DD}$	-0.3 ~ 6.0	V
Input voltage	$V_I$	-0.3 ~ $V_{DD} + 0.3$	V
Output voltage	$V_O$	-0.3 ~ $V_{DD} + 0.3$	V
Operation temperature	$T_{OPR}$	-30 ~ +70	°C
Storage tempetature	$T_{STR}$	-55 ~ +150	°C

5-2. DC Characteristics ( $V_{DD}=+5V\pm 10\%$ ,  $T_{OPR}=-30\sim+70^{\circ}C$ )

Parameter	Symbol	Condition	MIN.	TYP.	MAX.	Unit	Note
Input "Low" voltage	$V_{IL1}$				1.5	V	1
Input "High" voltage	$V_{IH1}$		3.5			V	
Input "Low" voltage	$V_{TL+}$				3.7	V	2
Input "High" voltage	$V_{TH-}$		1.0			V	
Hysterisis voltage	$V_{TH+} - V_{TL-}$		0.2			V	
Input "Low" current	$ I_{IL1} $	$V_I = 0V$			2.0	$\mu A$	3
	$ I_{IL2} $	$V_I = 0V$	8.0		75	$\mu A$	4
Input "High" current	$ I_{IH1} $	$V_I = V_{DD}$			2.0	$\mu A$	5
	$ I_{IH2} $	$V_I = V_{DD}$	8.0		75	$\mu A$	6
Output "High" voltage	$V_{OH1}$	$I_{OH} = -2mA$	4.0			V	7
Output "Low" voltage	$V_{OL1}$	$I_{OL} = 4mA$			0.4	V	
Output "High" voltage	$V_{OH2}$	$I_{OH} = -6mA$	4.0			V	8
Output "Low" voltage	$V_{OL2}$	$I_{OL} = 8mA$			0.4	V	
Output "High" voltage	$V_{OH3}$	$I_{OH} = -9mA$	4.0			V	9
Output "Low" voltage	$V_{OL3}$	$I_{OL} = 12mA$			0.4	V	
Output "Low" voltage	$V_{OL4}$	$I_{OL} = 4mA$			0.4	V	10
Leak output current	$ I_{OZ} $	High-Z			1.0	$\mu A$	

Note 1 : Applied to Inputs(IC, ICD, ICU, IBF0).

Note 2 : Applied to Input (ICSU)

Note 3 : Applied to Inputs(IC, ICD, IBF0).

Note 4 : Applied to Inputs(ICU, ICSU).

Note 5 : Applied to Inputs(IC, ICU, IBF0).

Note 6 : Applied to Input (ICD).

Note 7 : Applied to (O, OSC0).

(Output(OSC0) measures on conditions that input(OSCI) level is 0V or  $V_{DD}$ .)

Note 8 : Applied to Output(O6MA2).

Note 9 : Applied to Output(O6MA3).

Note 10 : Applied to Output(ON).

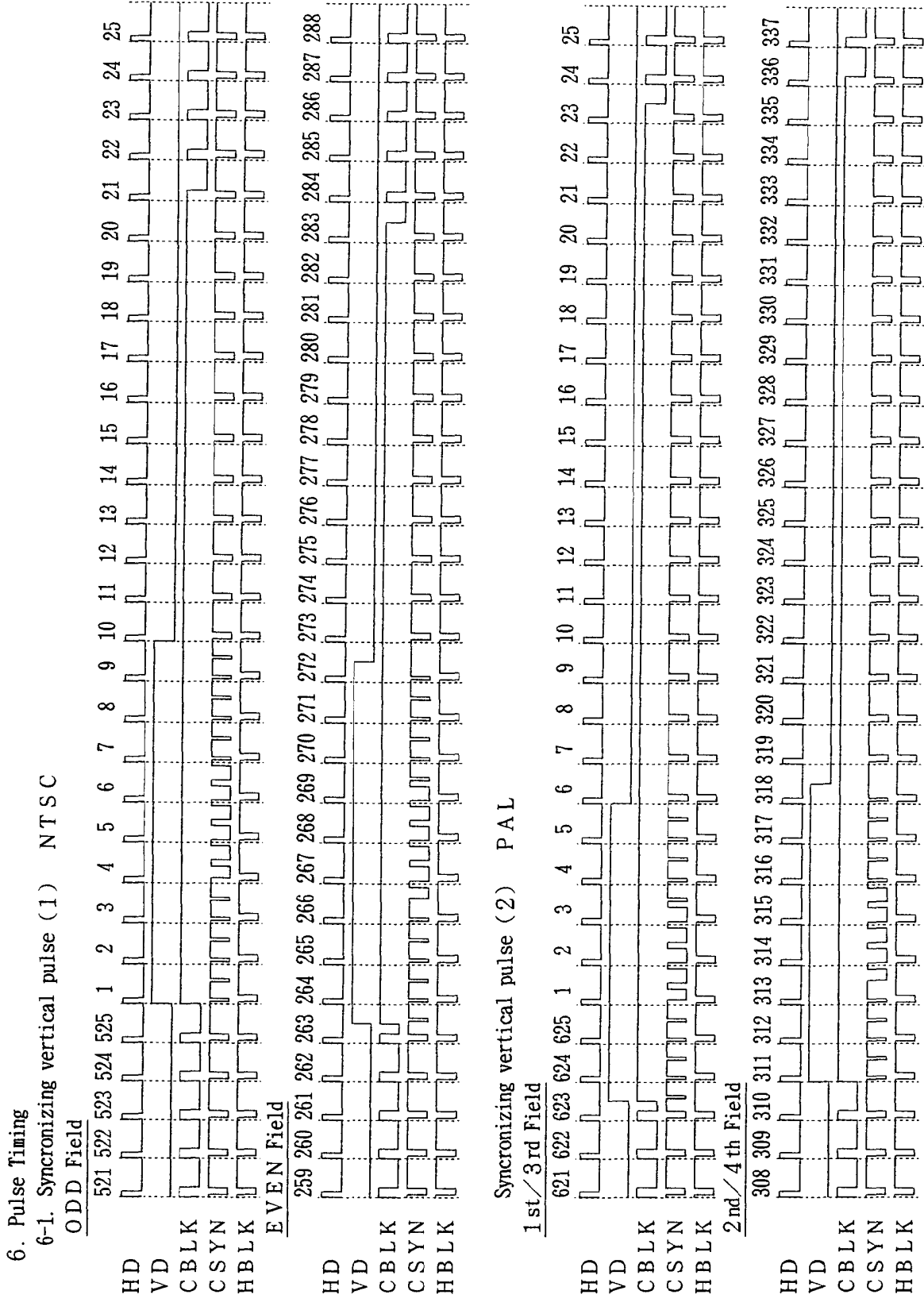



Synchronizing vertical pulse (4)

PAL 1st/3rd Field

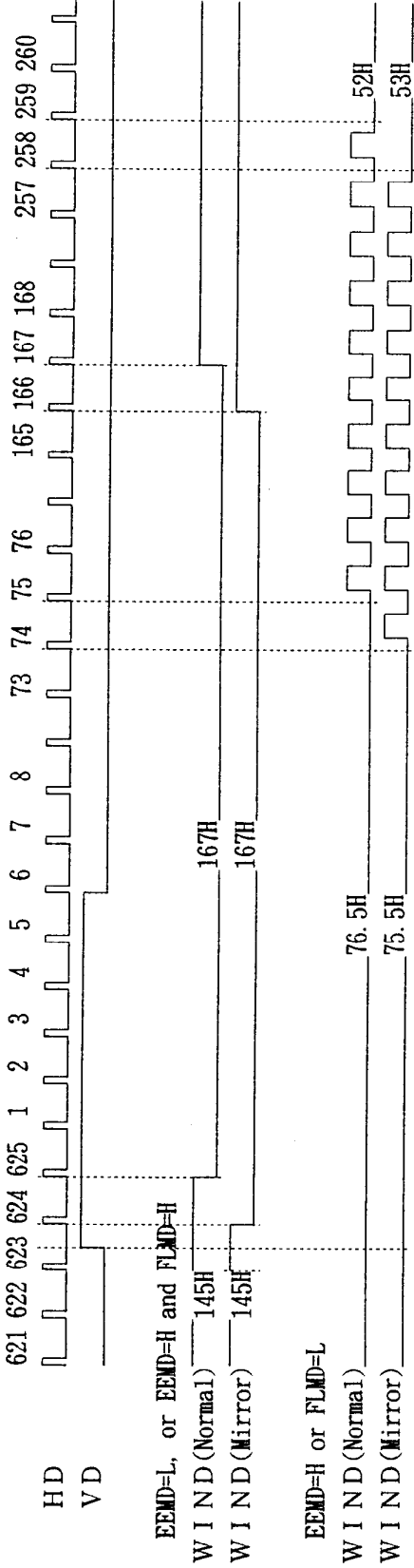

PAL 2nd/4th Field

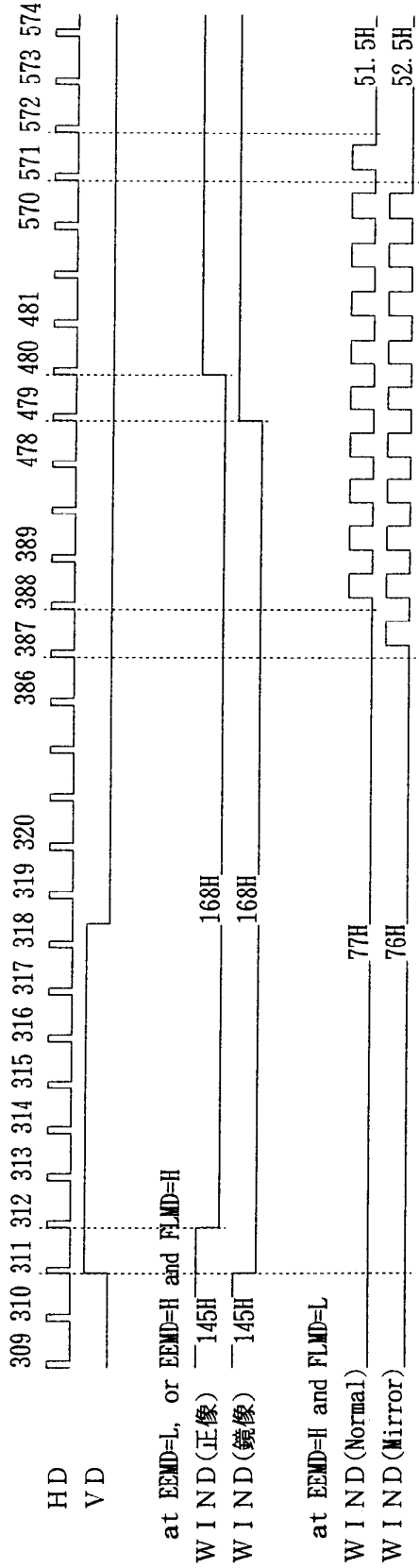

WIND ; N - c h open drain output

6-2. Vertical pulse for driving CCD (1) NTSC-1

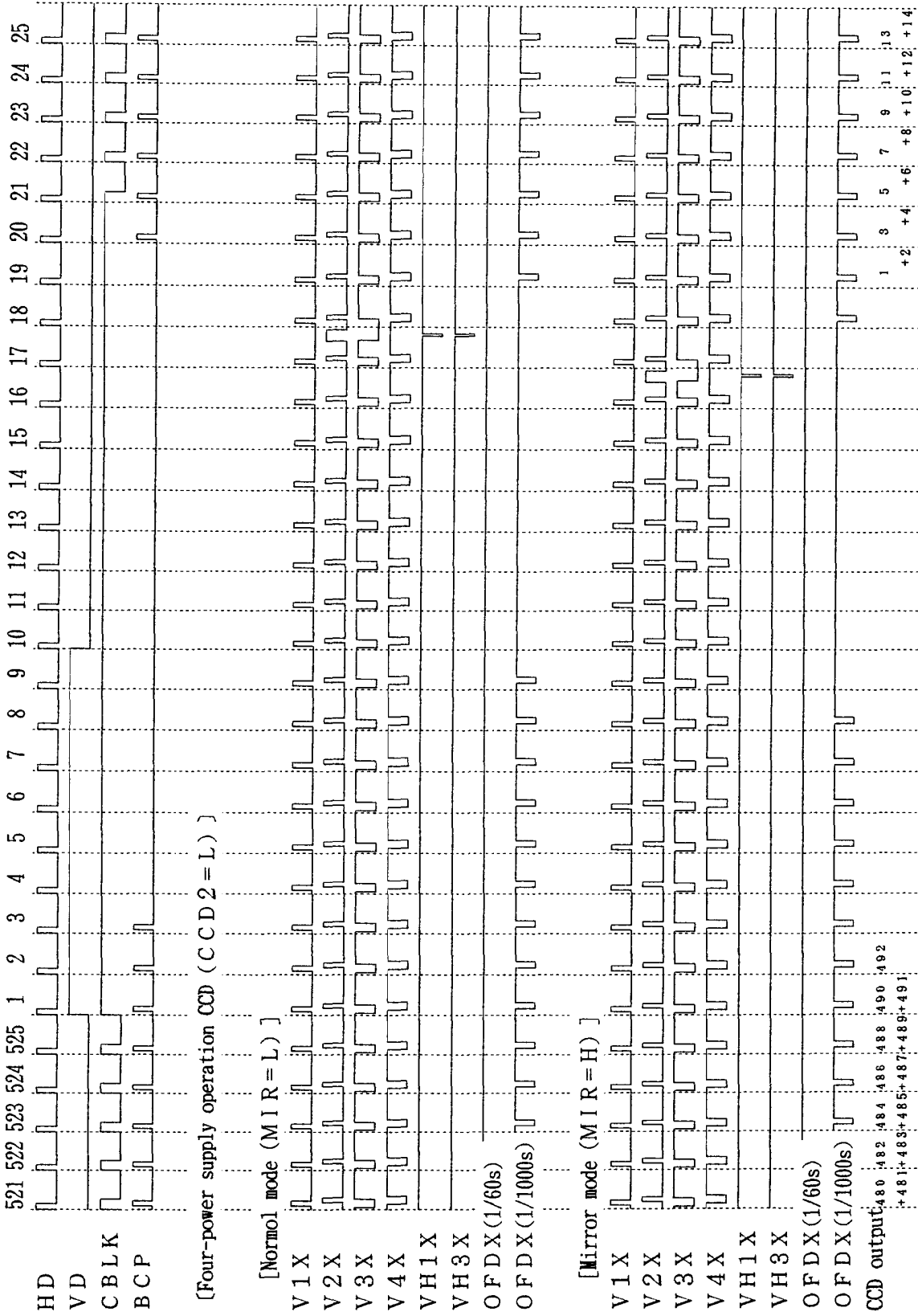



Vertical pulse for driving CCD (2) NTSC-2

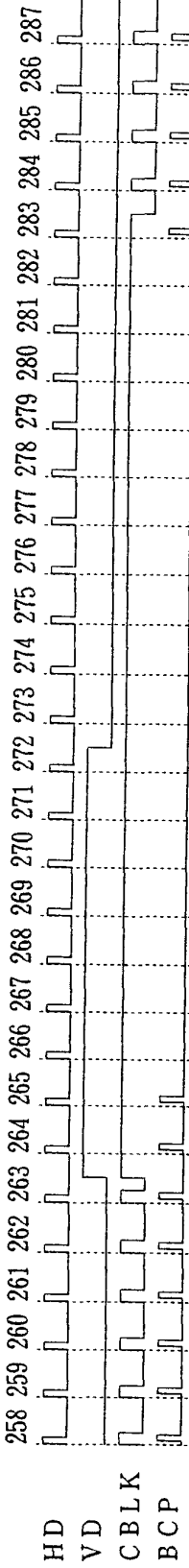

[Four-power supply operation CCD (CCD2=L)]

[Normal mode (MIR=L)]

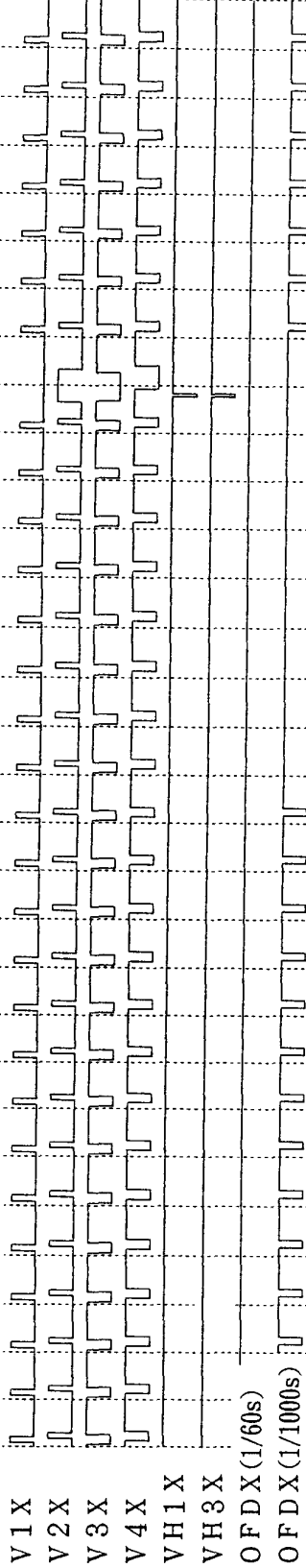

[Mirror mode (MIR=H)]

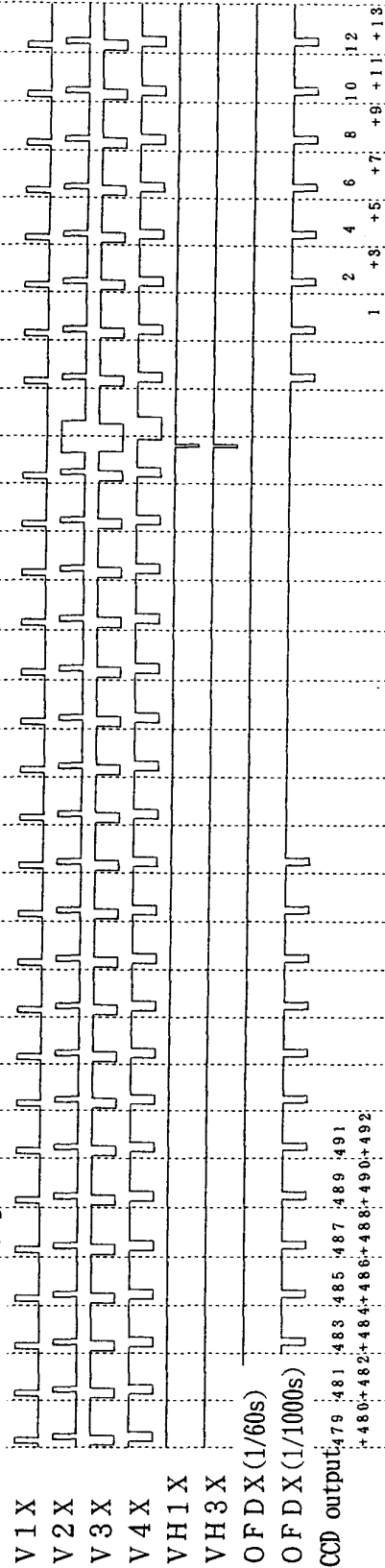

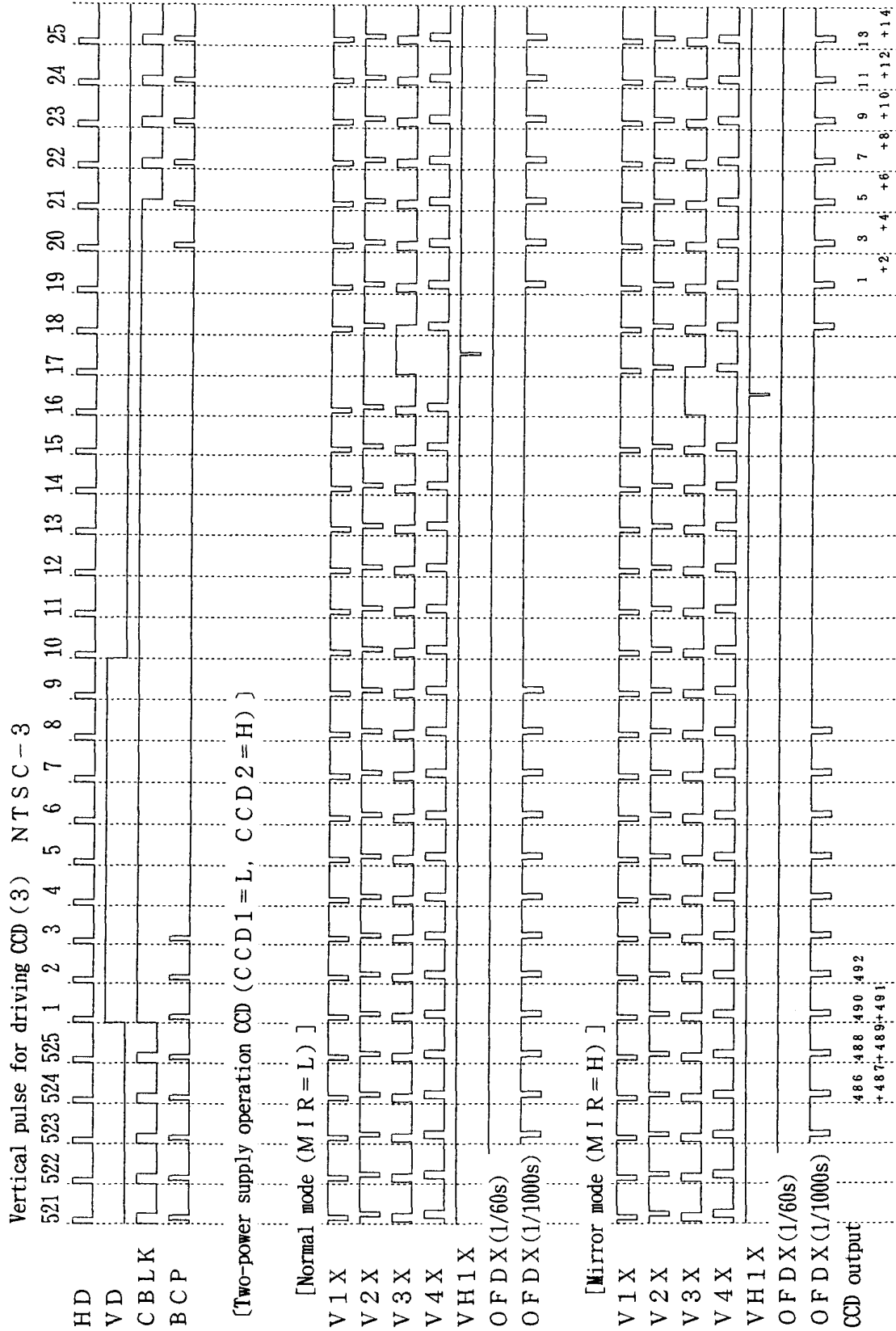

Vertical pulse for driving CCD (4) NTSC - 4

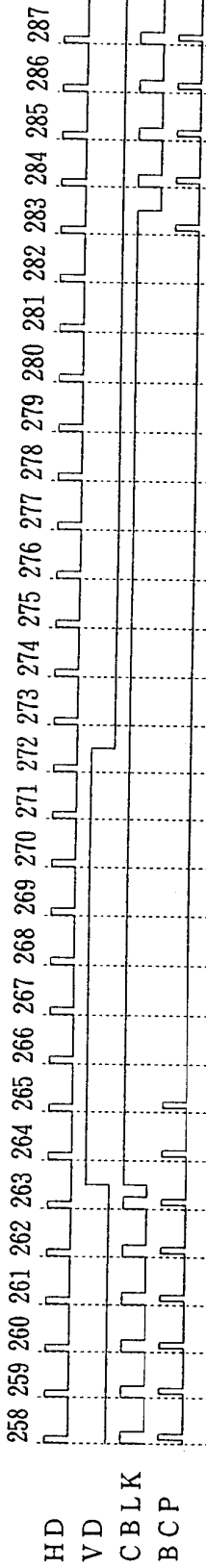

[Two-power supply operation CCD (CCD1 = L, CCD2 = H)]

[Normal mode (MIR = L)]

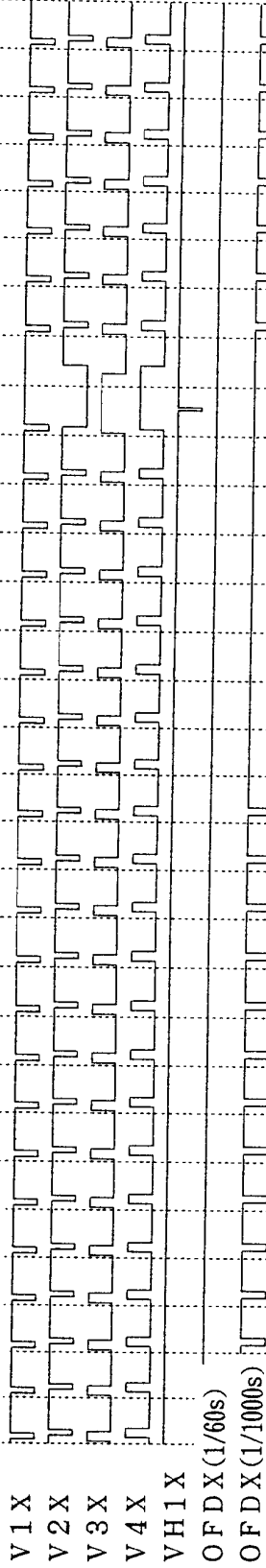

[Mirror mode (MIR = H)]

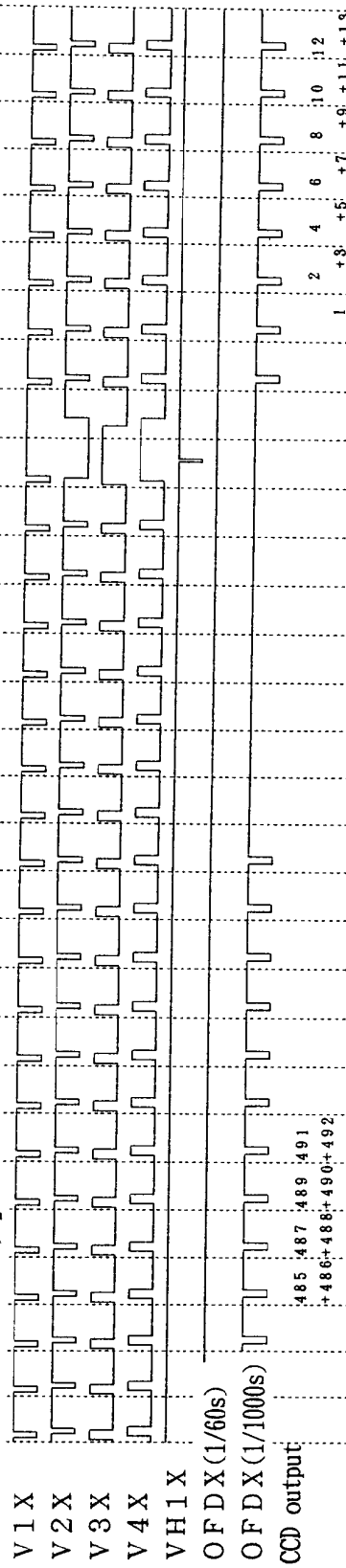

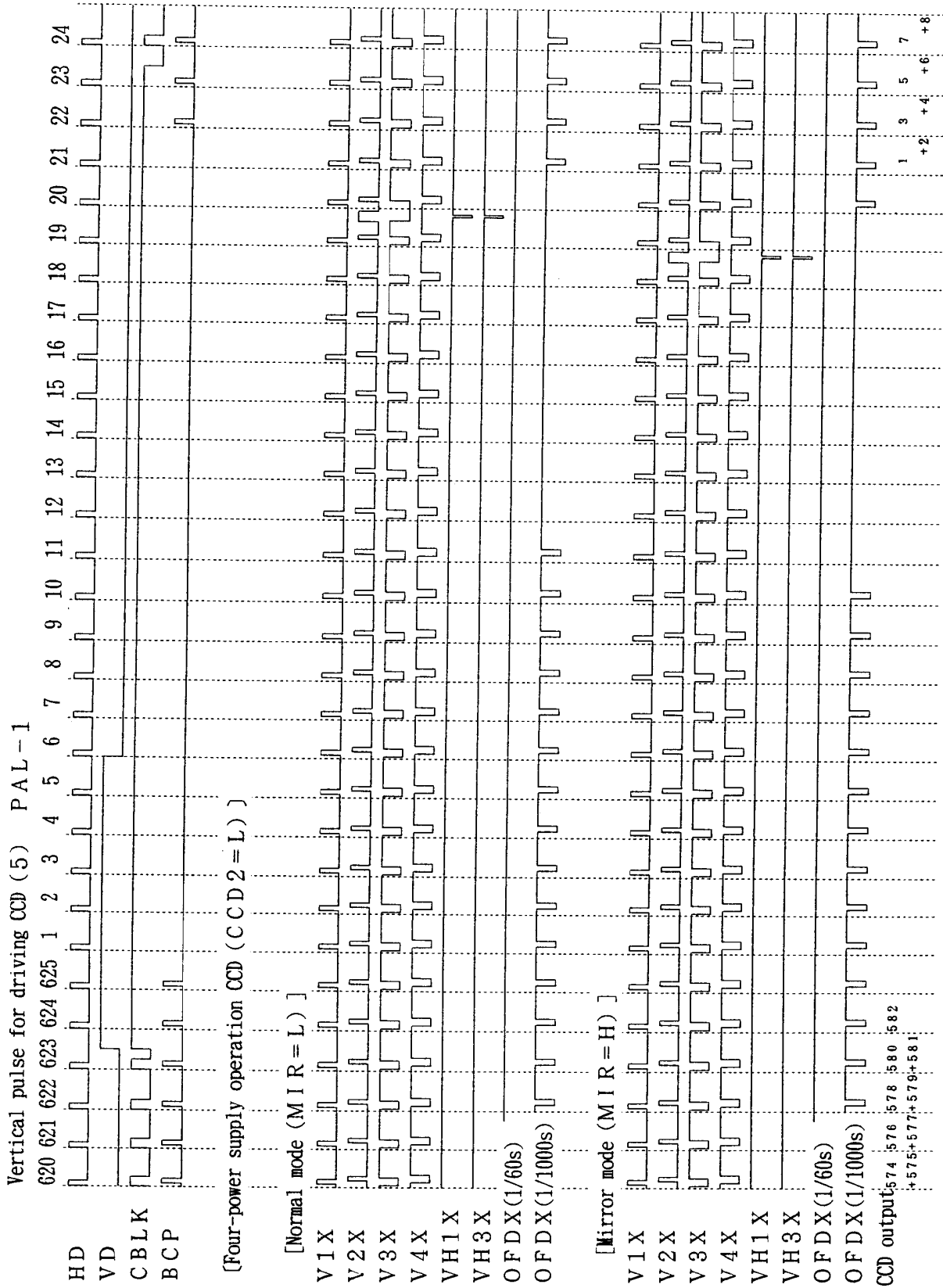

Vertical pulse for driving CCD (6) PAL-2

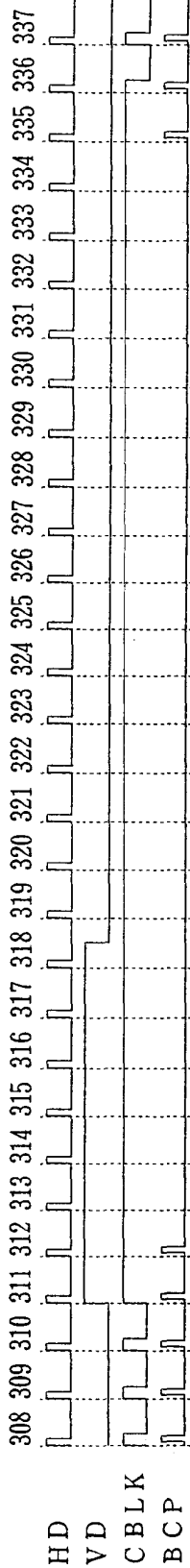

[Four-power supply operation CCD (CCD2=L)]

[Normal mode (MIR=L)]

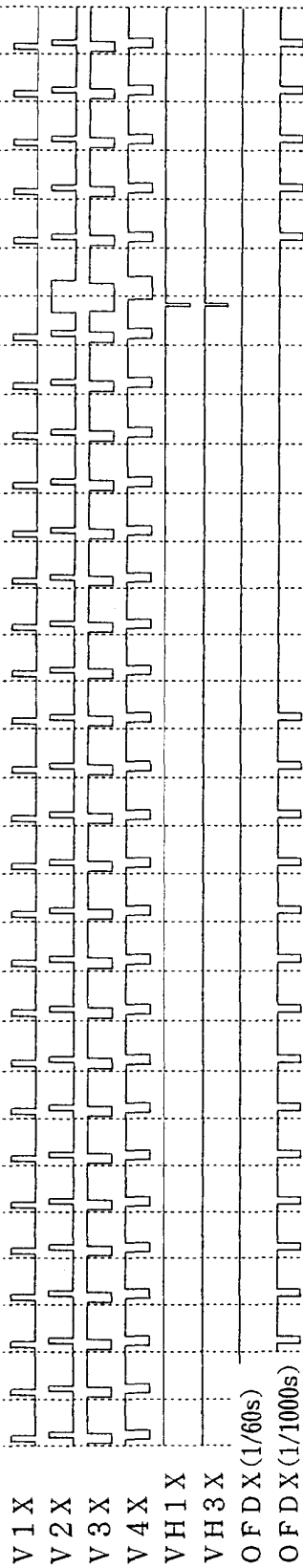

[Mirror mode (MIR=H)]

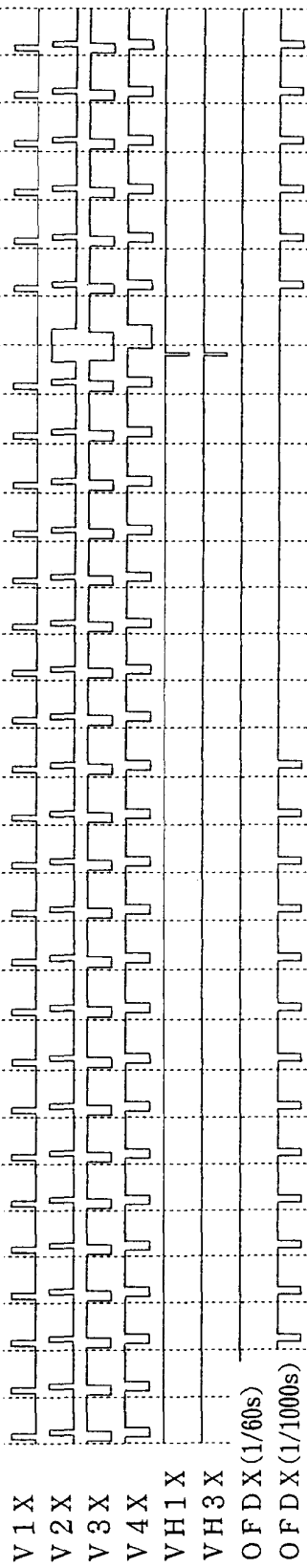

CCD output: 575 577 579 581  
+576+578+580+582

1 2 4 6 8  
+3 +5 +7 +9

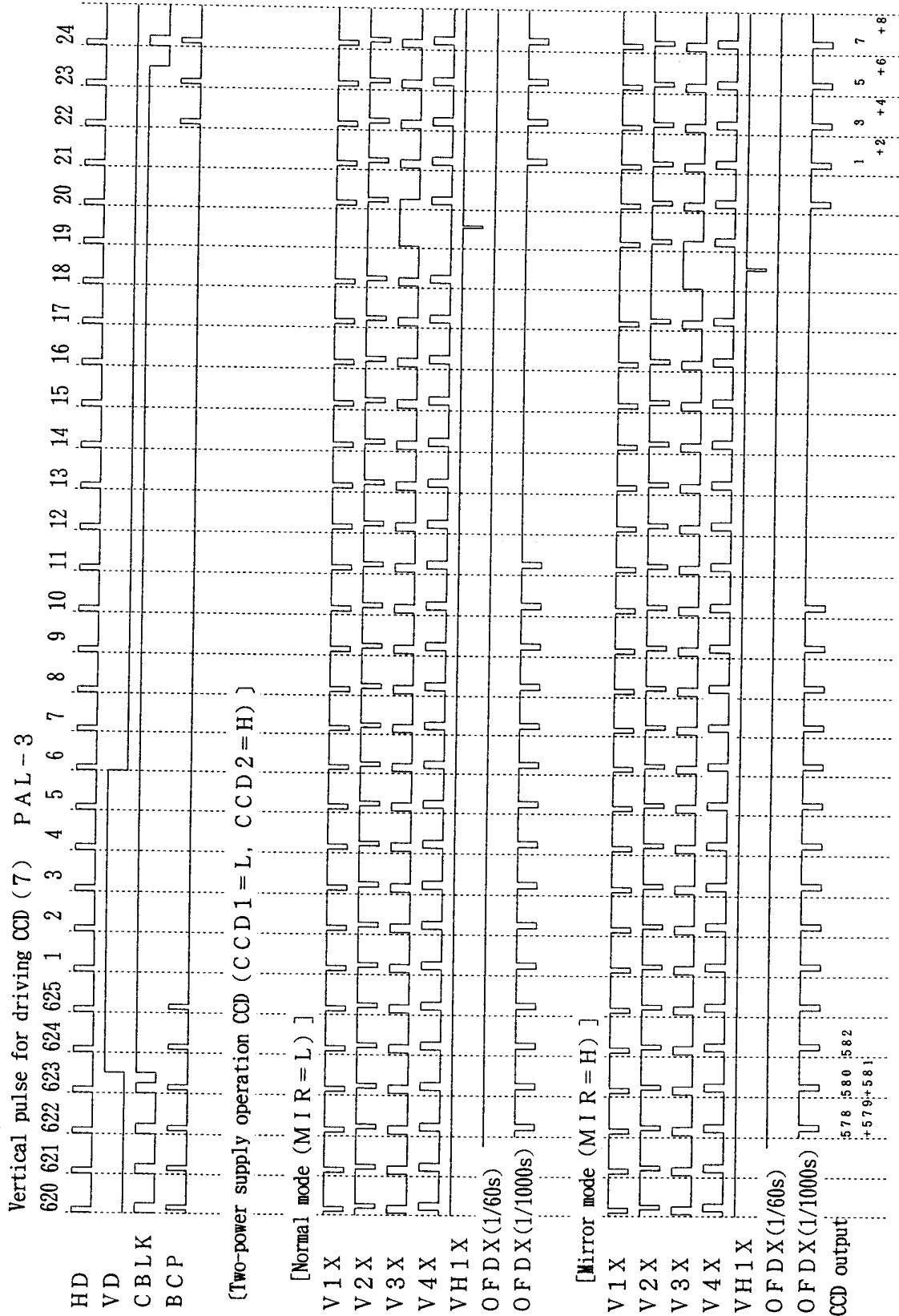

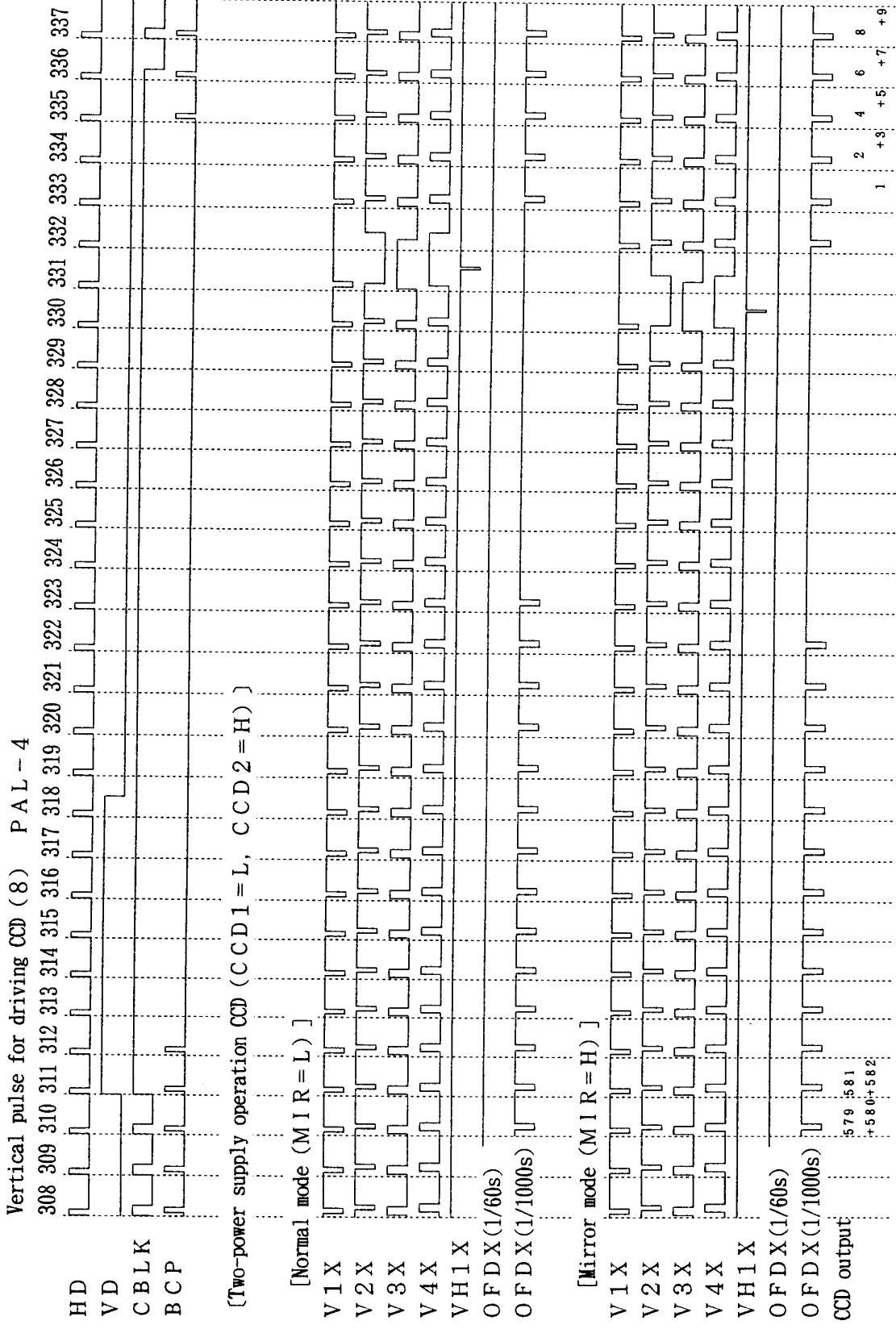

### 6-3. Synchronizing horizontal pulse

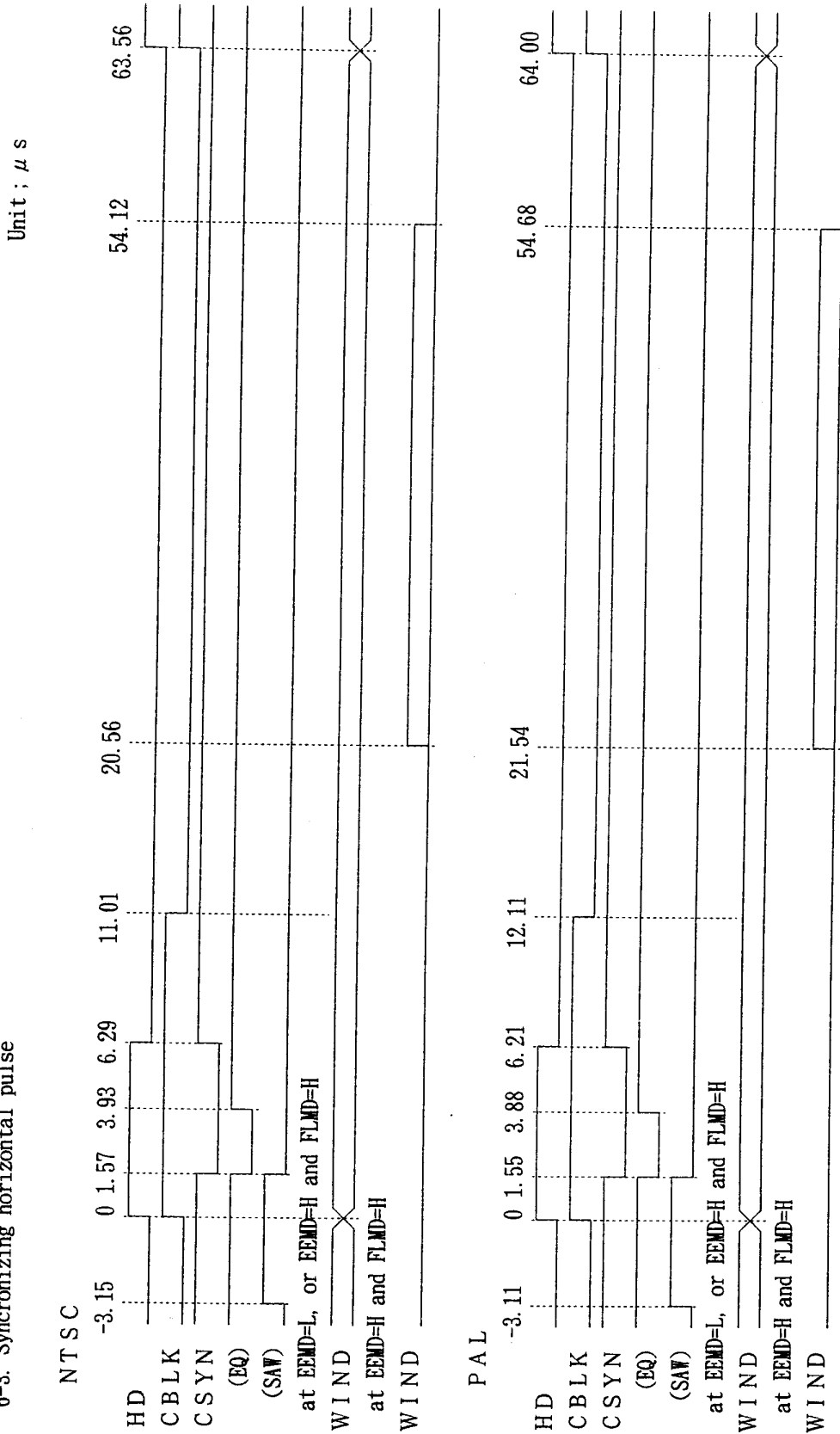

WIND ; N - c h open drain output



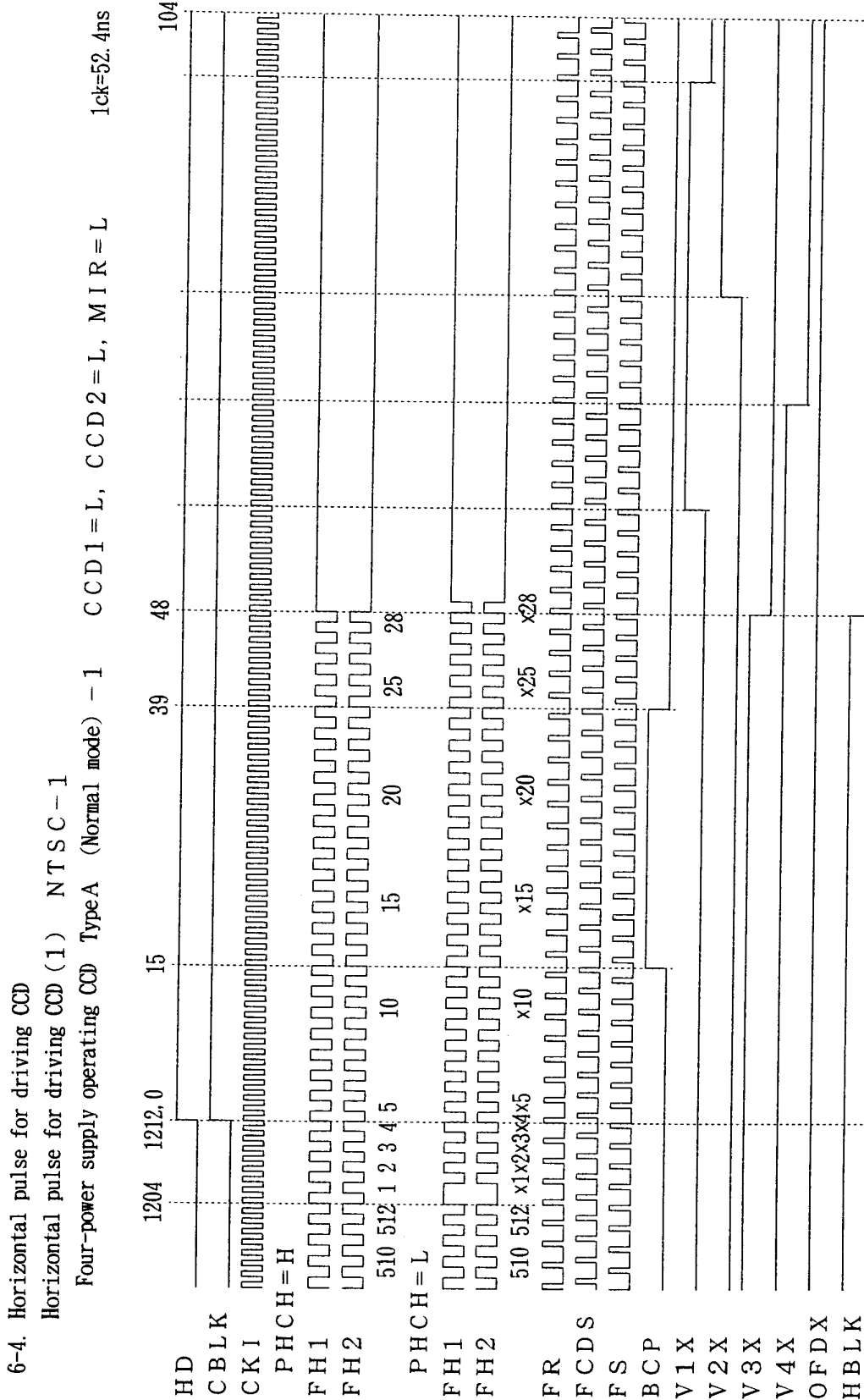

Horizontal pulse for driving CCD (2) NTSC-2  
 Four-power supply operation CCD TypeA (Normal mode) - 2 CCD1=L, CCD2=L, MIR=L 1clk=52.4ns

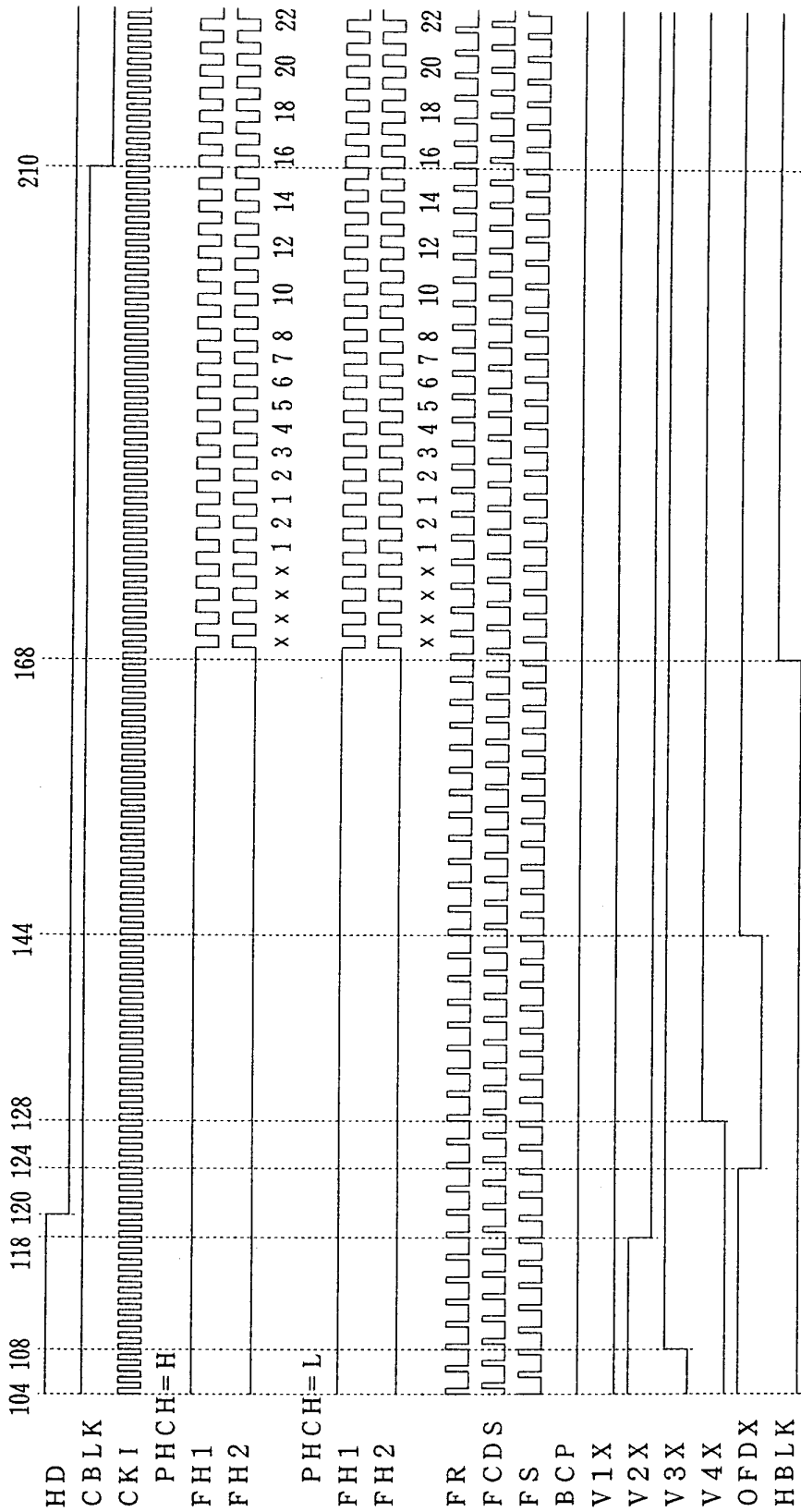

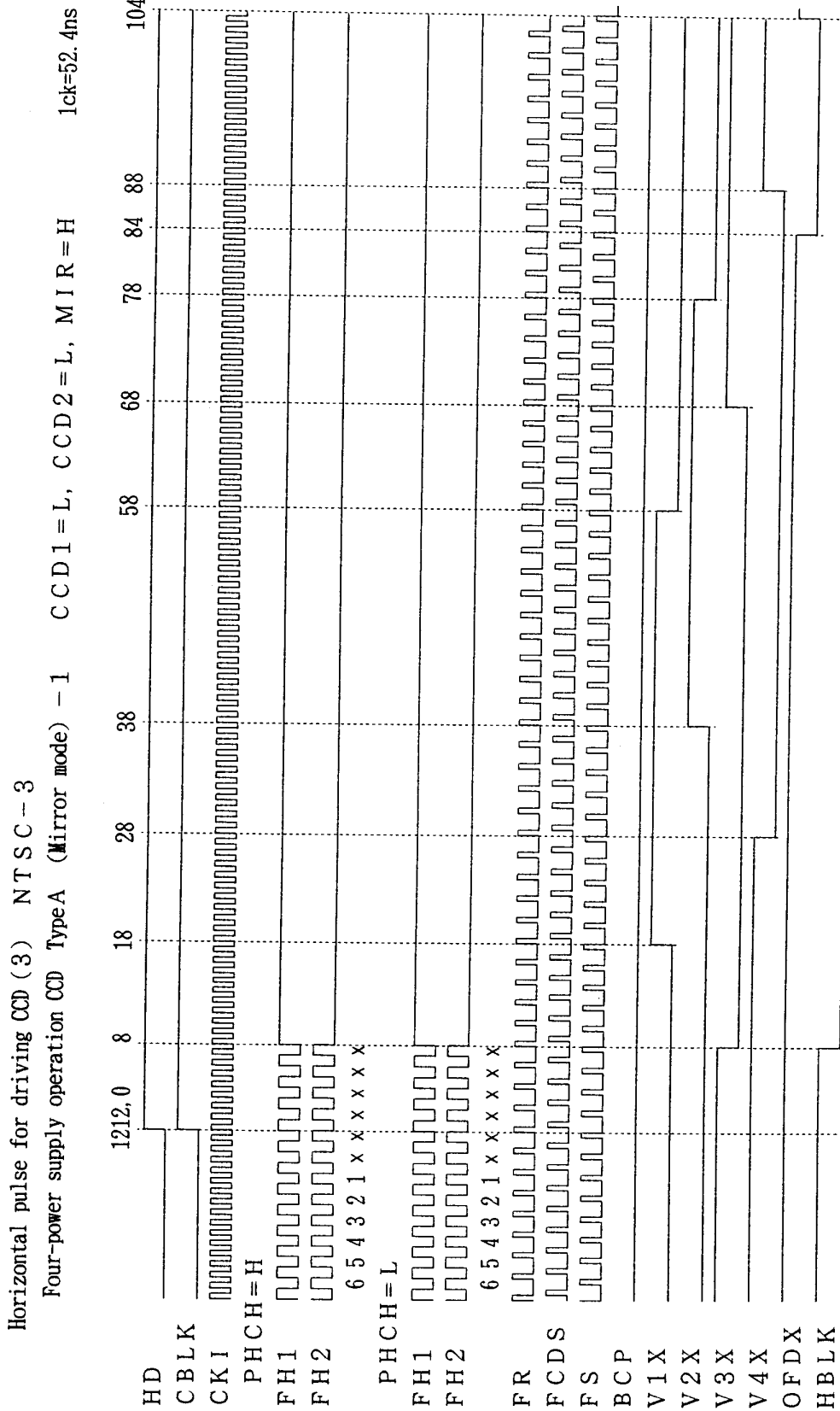

Horizontal pulse for driving CCD (4) NTSC-4  
 Four-power supply operation CCD TypeA (Mirror mode) - 2 CCD 1 = L, CCD 2 = L, MIR = H 1ck=52.4ns

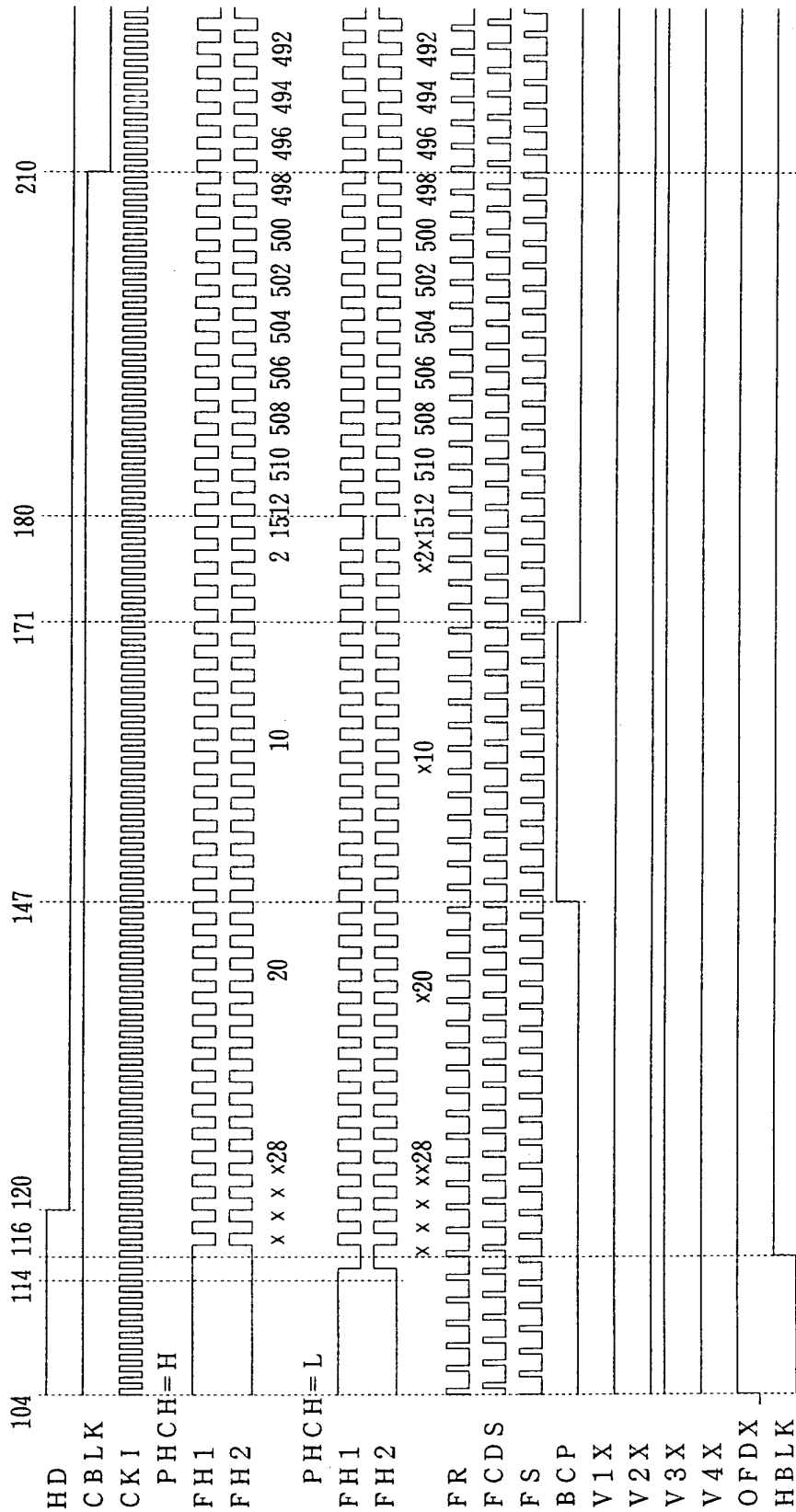

Horizontal pulse for driving CCD (5) NTSC-5  
 Four-power supply operation CCD Type B (Normal mode) - 1 CCD1 = H, CCD2 = L, MIR = L 1clk=52.4ns

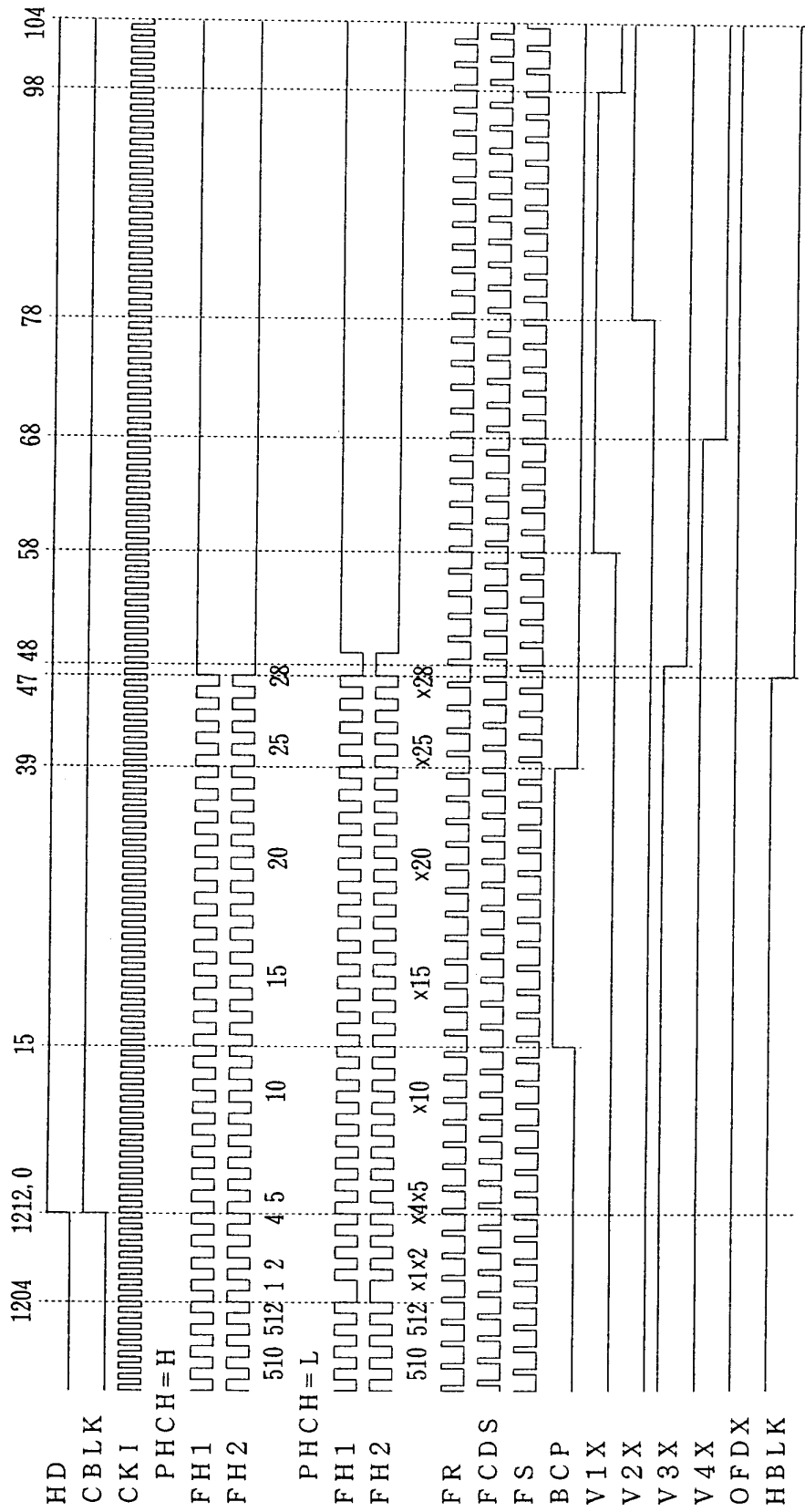

Horizontal pulse for driving CCD (6) NTSC-6  
 Four-power supply operation CCD Type B (Normal mode) - 2 CCD1=H, CCD2=L, MIR=L 1clk=52.4ns

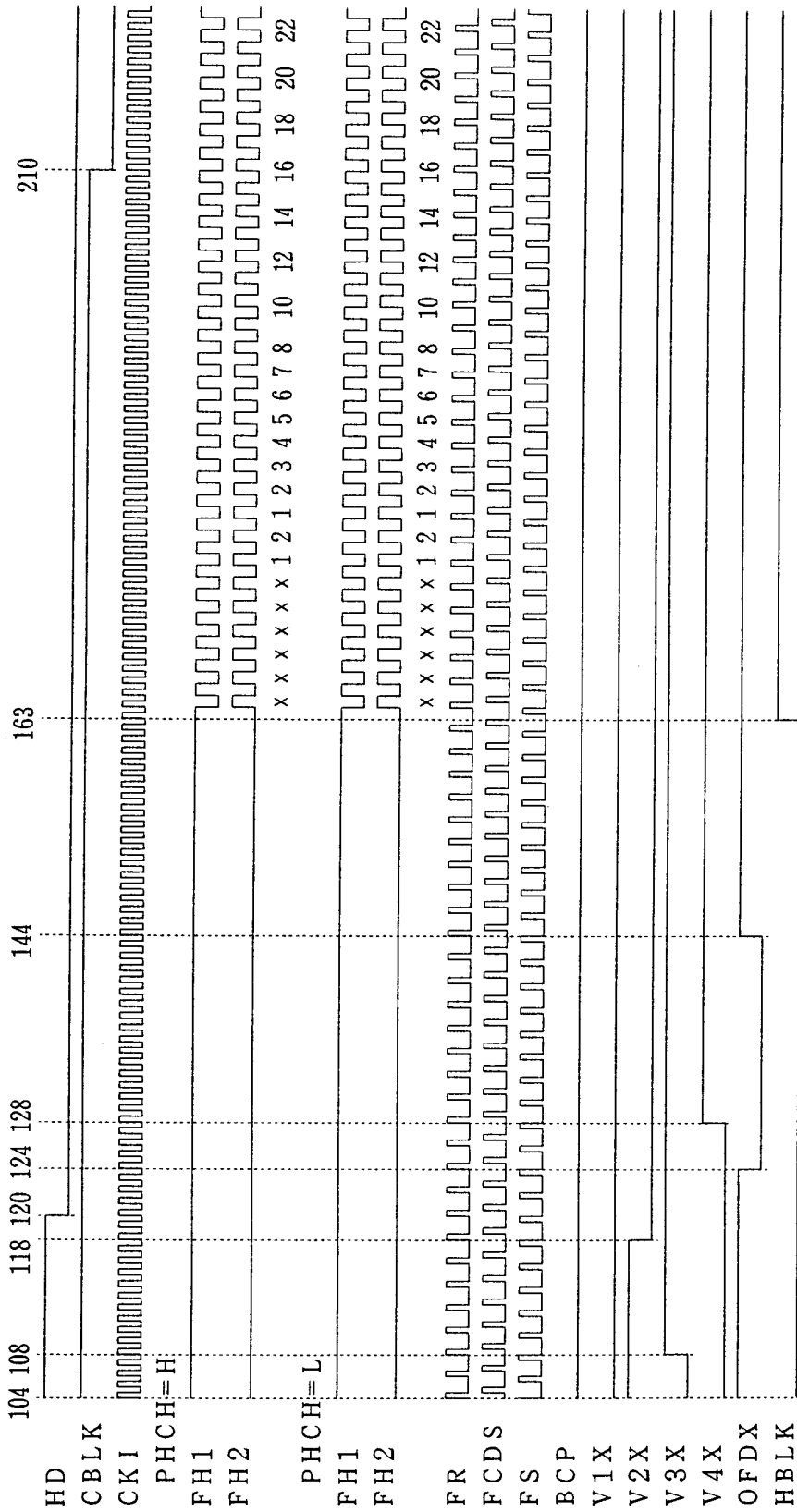

Horizontal pulse for driving CCD (7) N T S C - 7

Two-power supply operation CCD (Normal mode) - 1 CCD 1 = L, CCD 2 = H, MIR = L

1clk=52.4ns

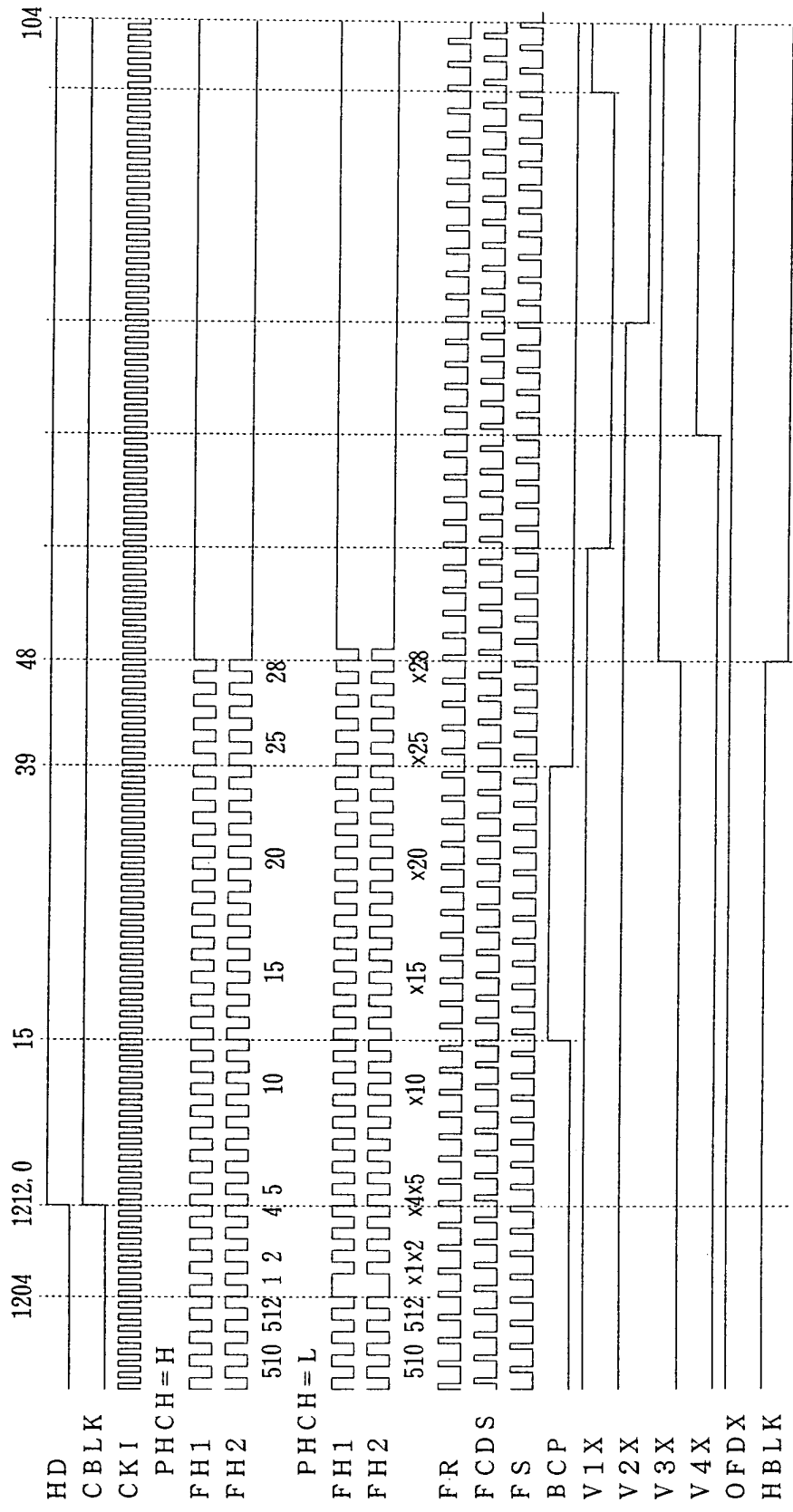

Horizontal pulse for driving CCD (8) NTSC-8  
 Two-power supply operation CCD (Normal mode) - 2 CCD1=L, CCD2=H, MIR=L

1clk=52.4ns

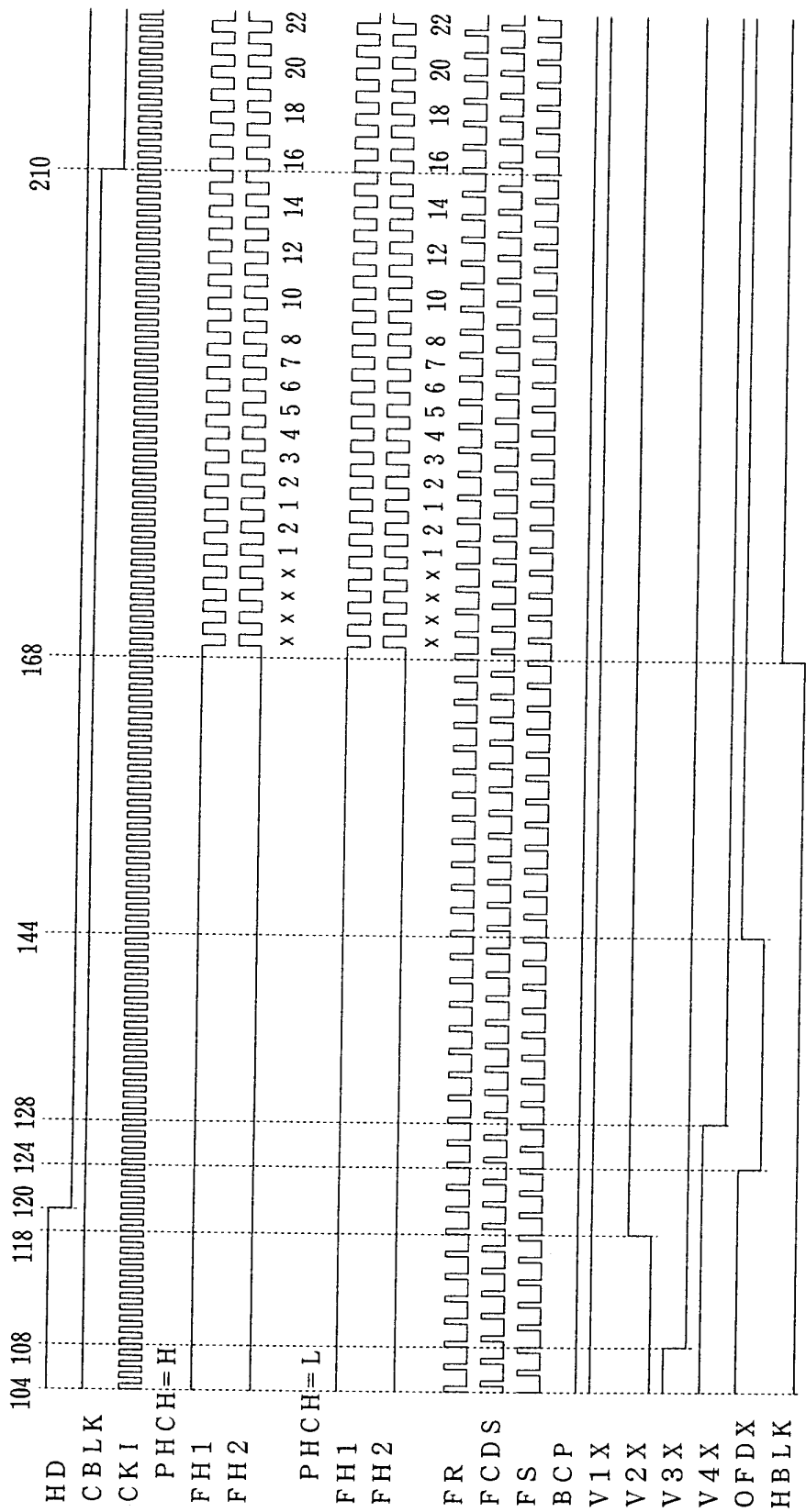



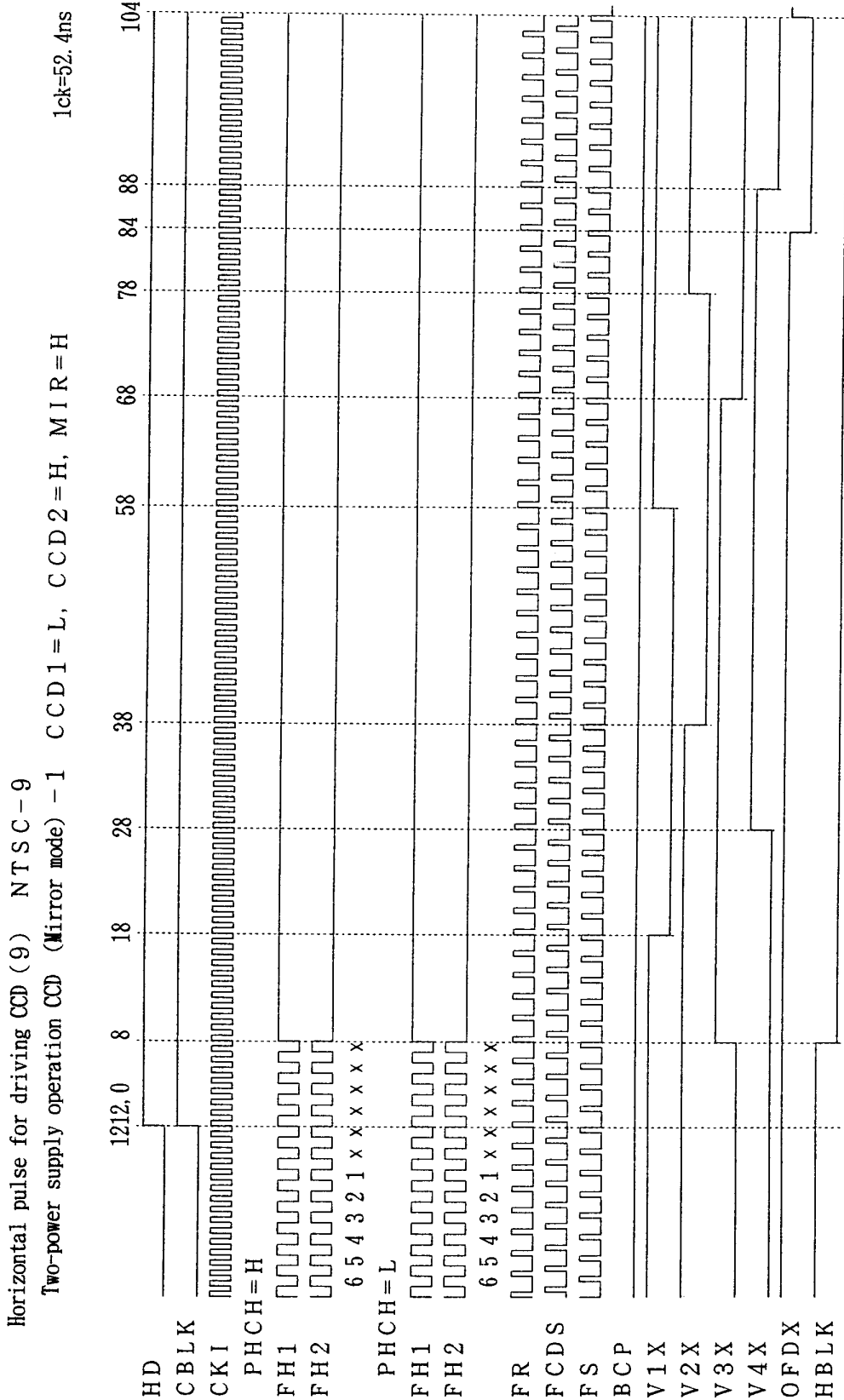

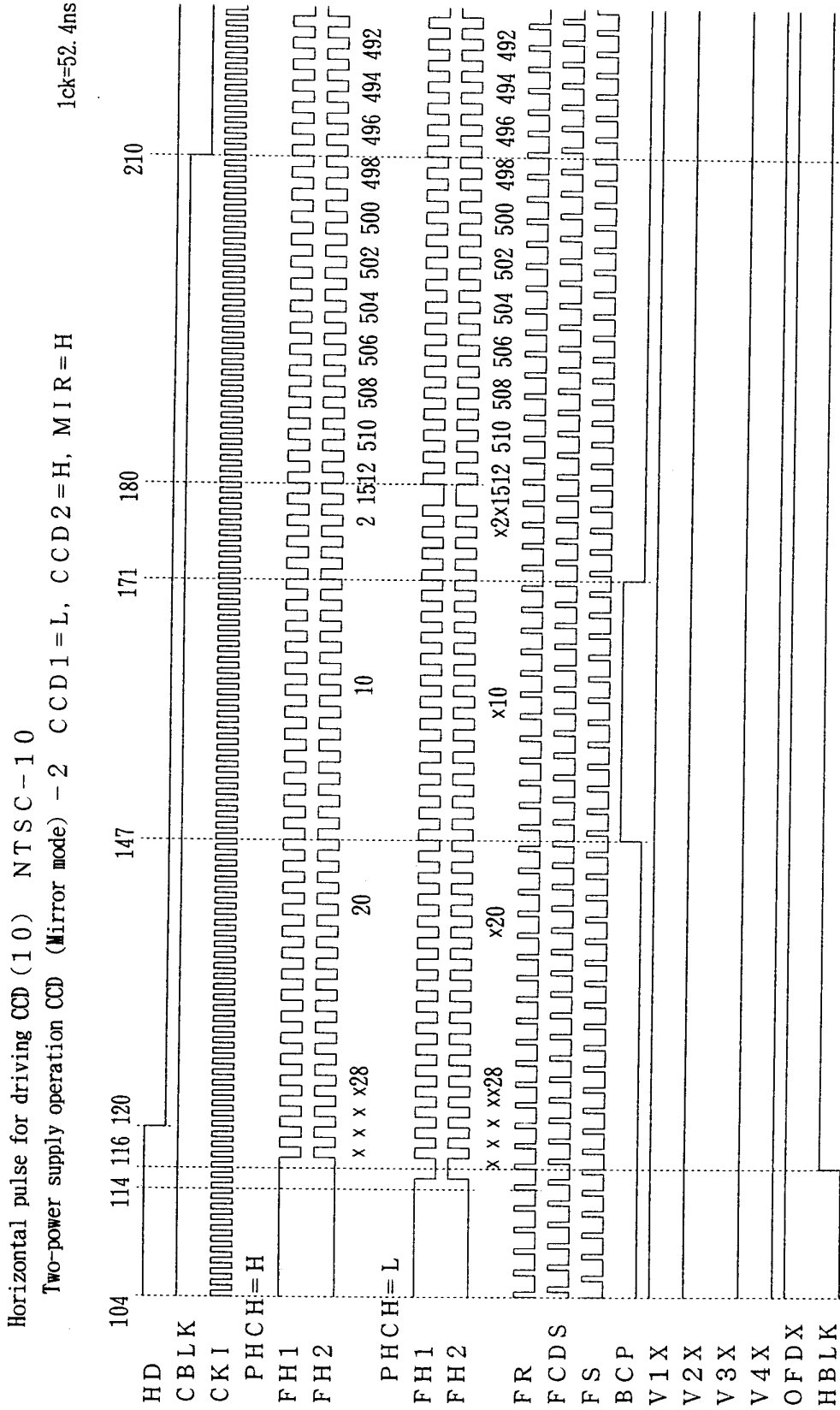

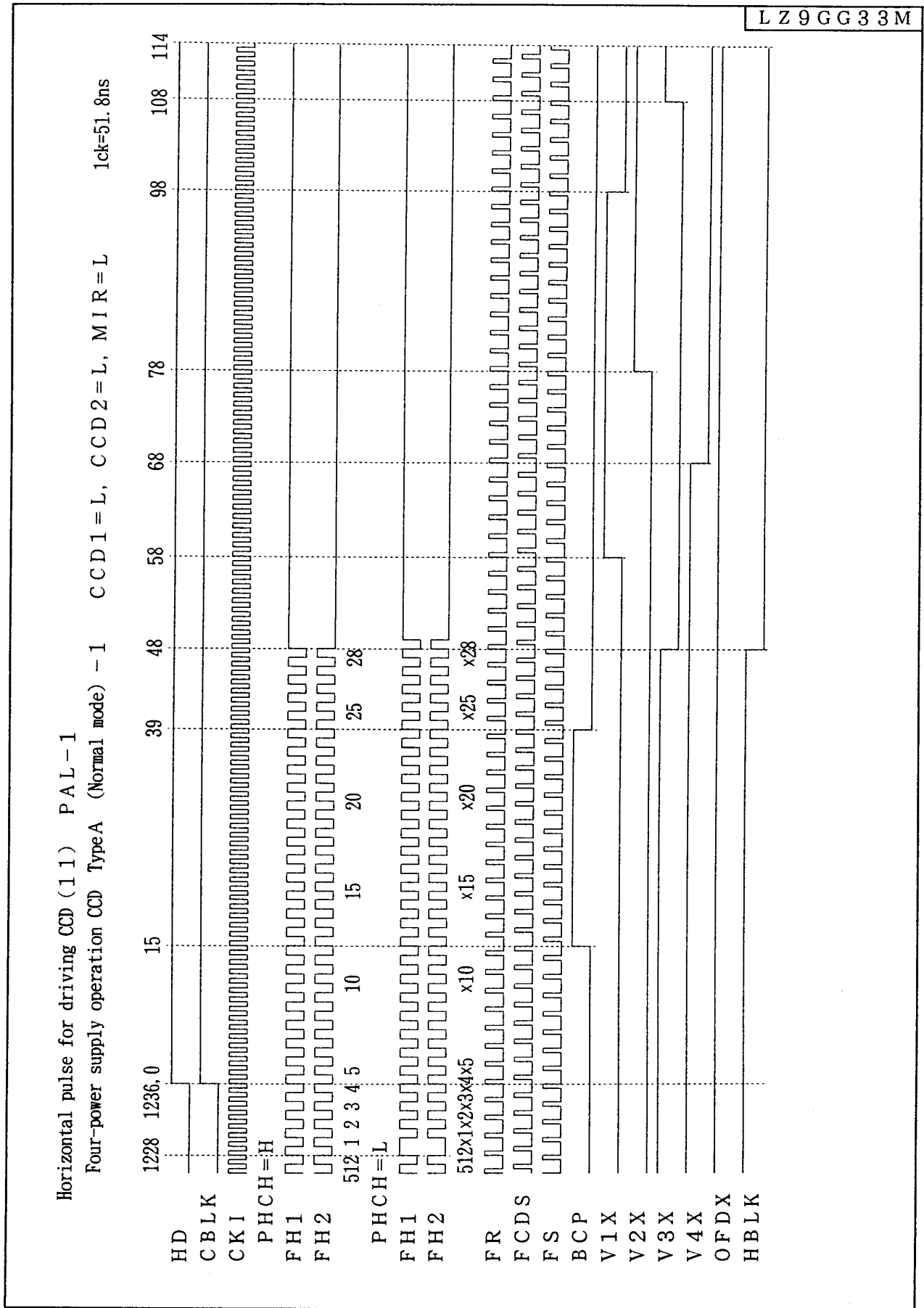

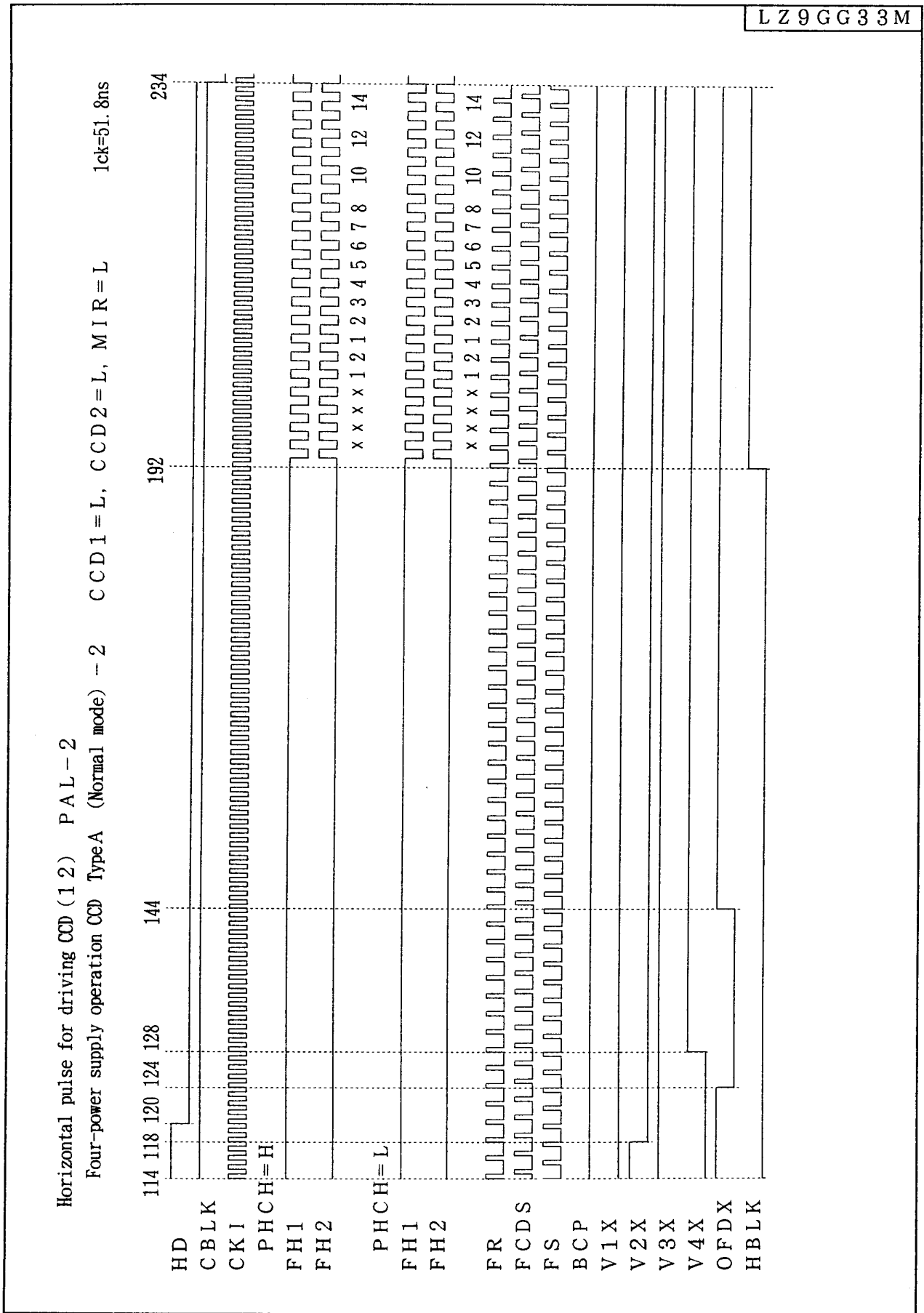

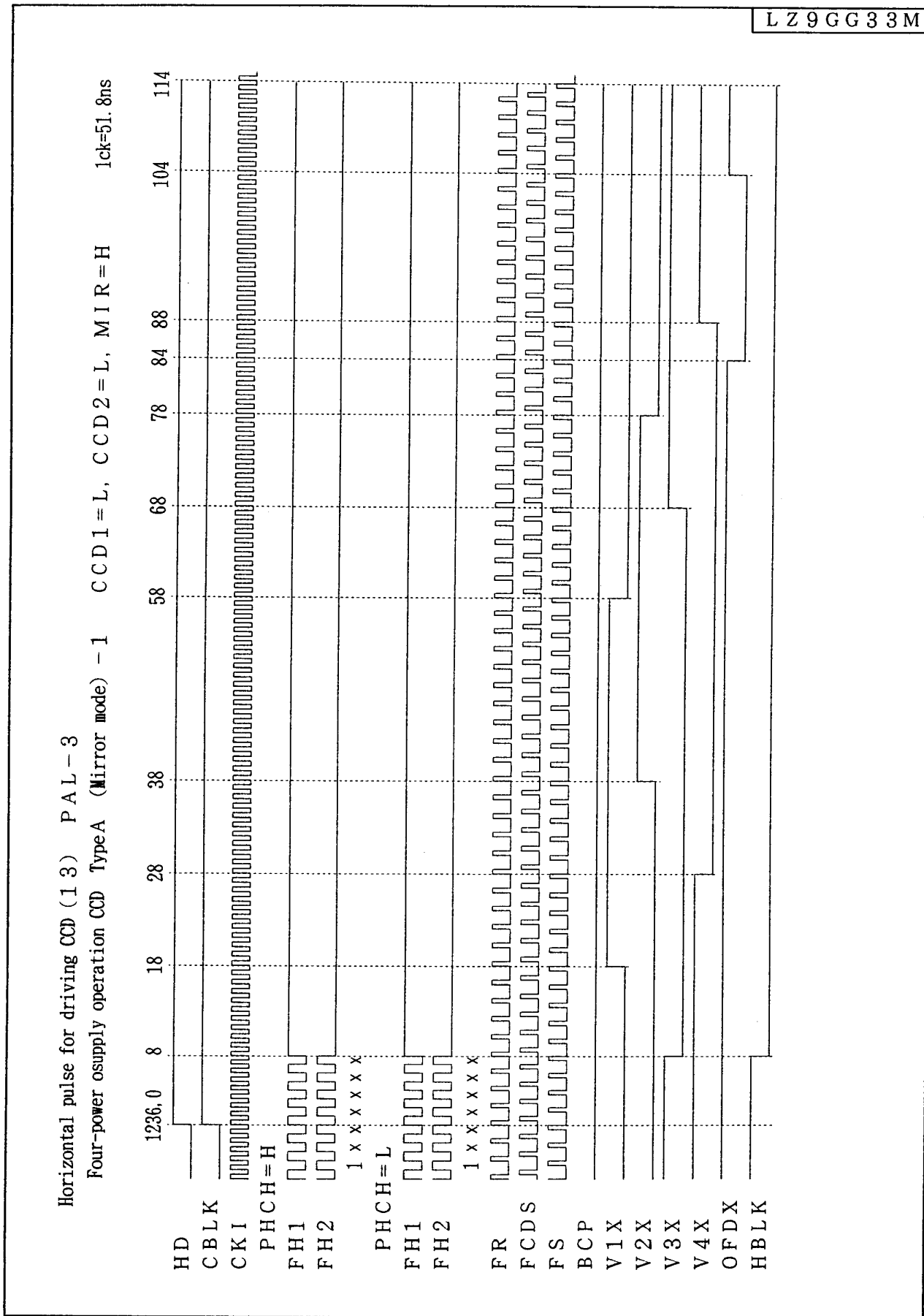

LZ9GG33M

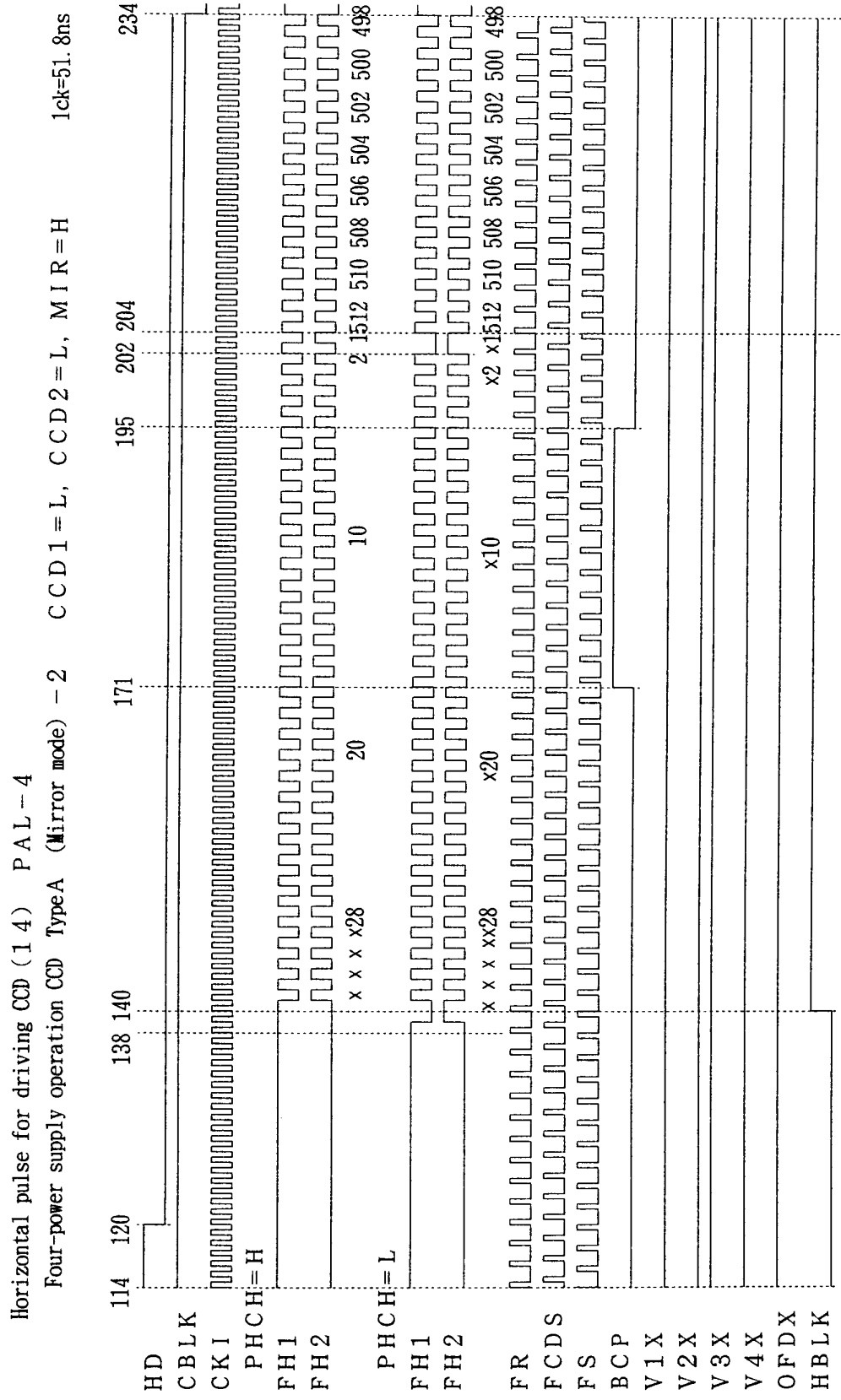

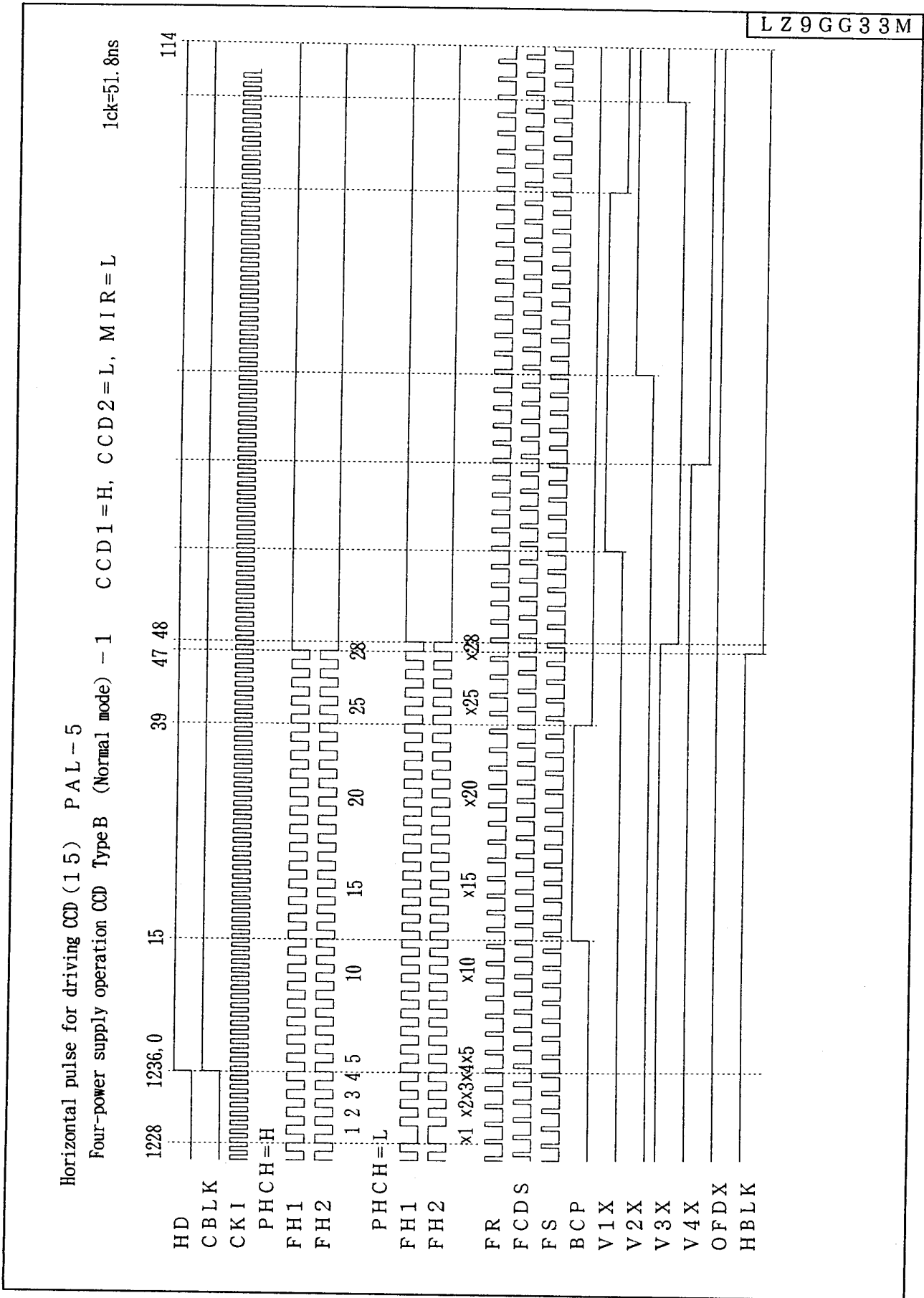

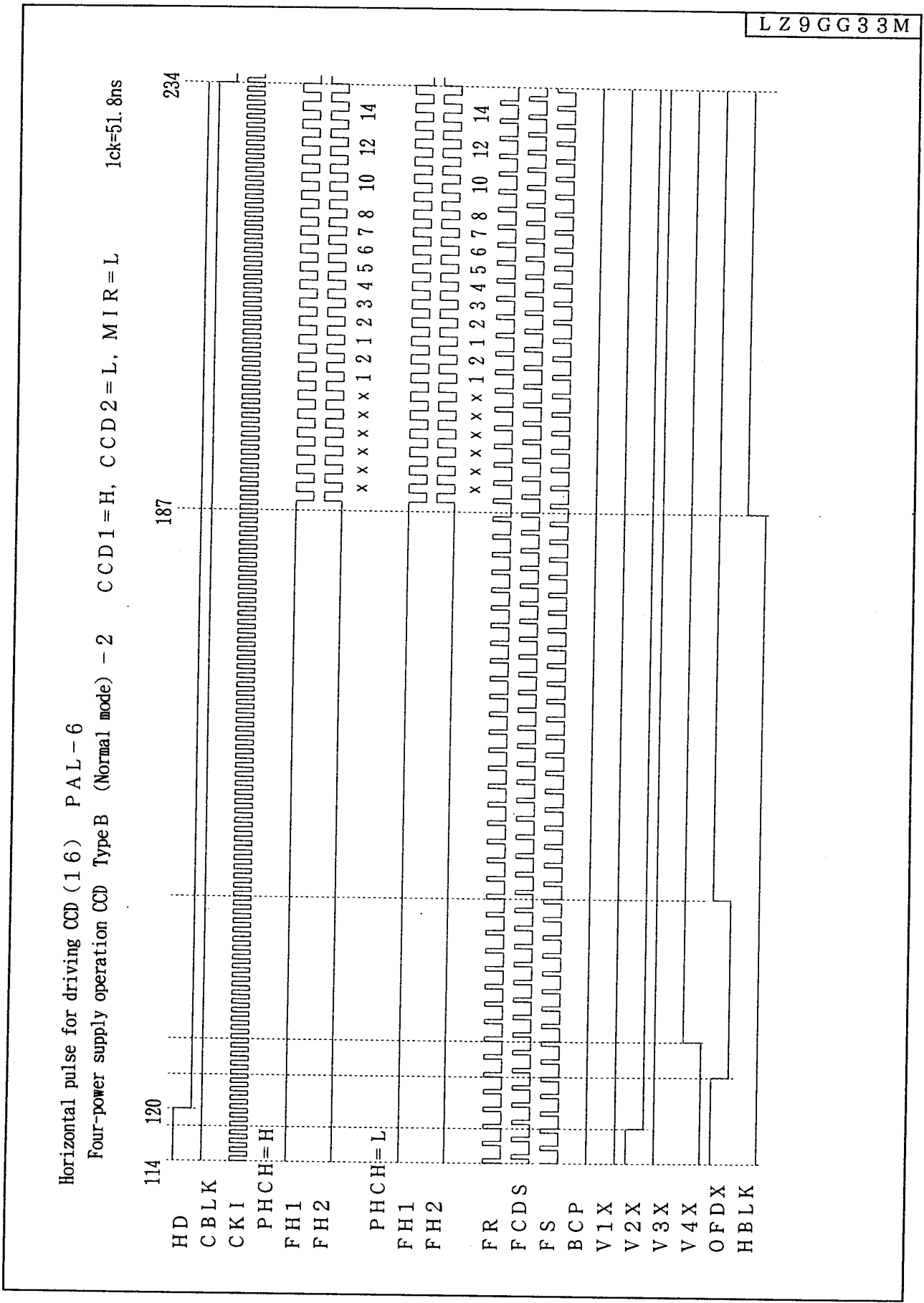



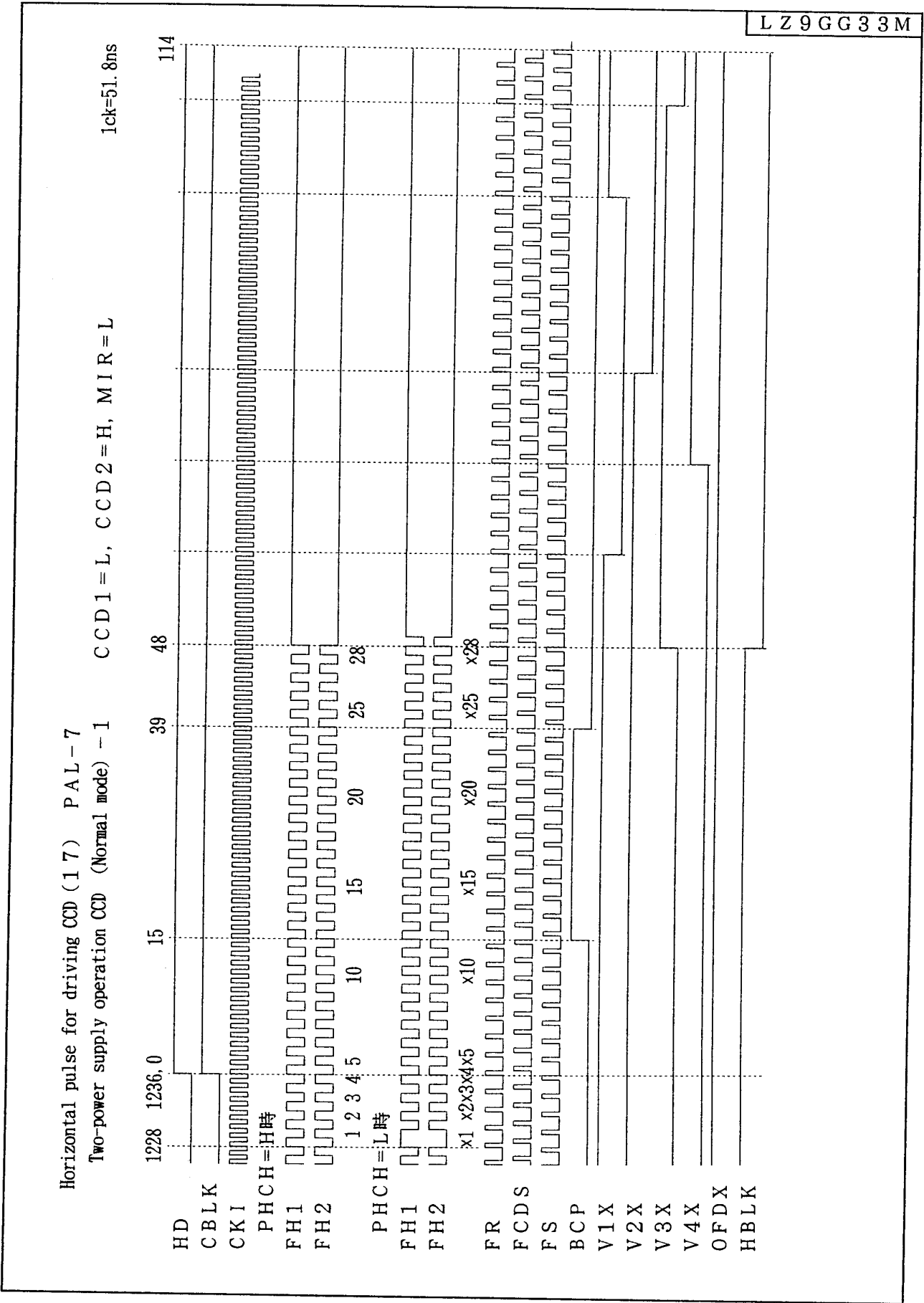

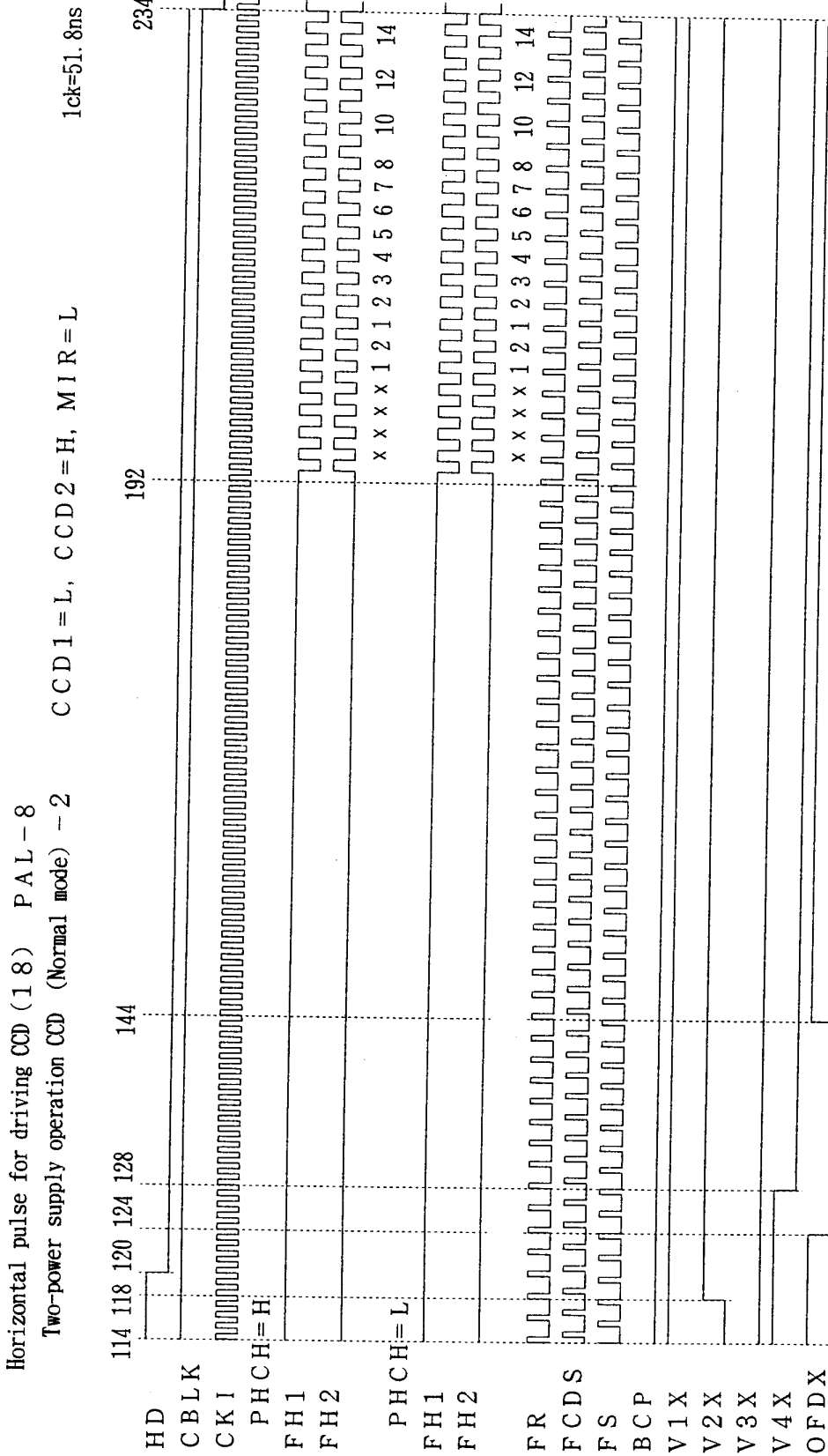

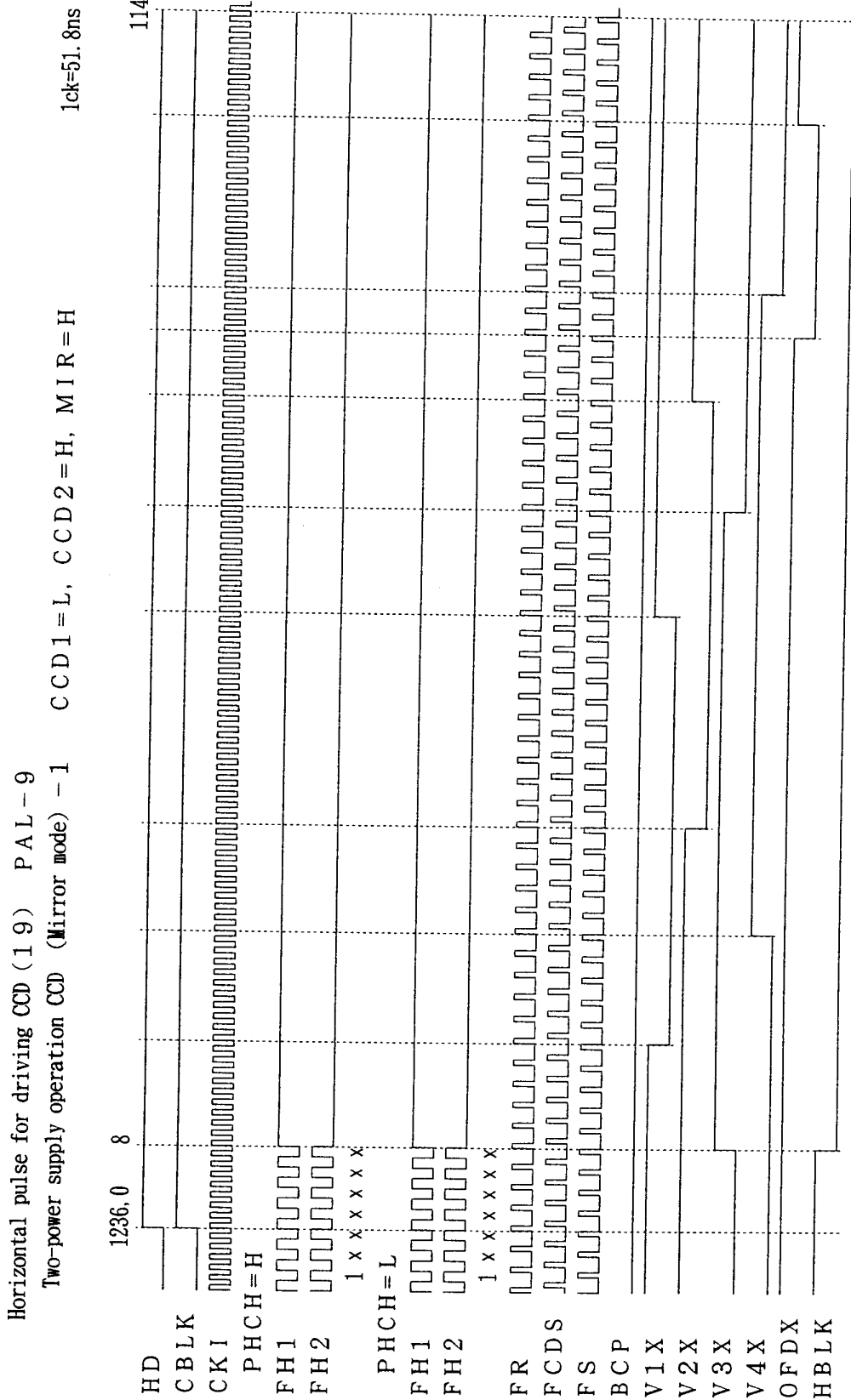

Horizontal pulse for driving CCD (20) PAL-10

Two-power supply operation CCD (Mirror mode) - 2 CCD1=L, CCD2=H, MIR=H

1ck=51.8ns

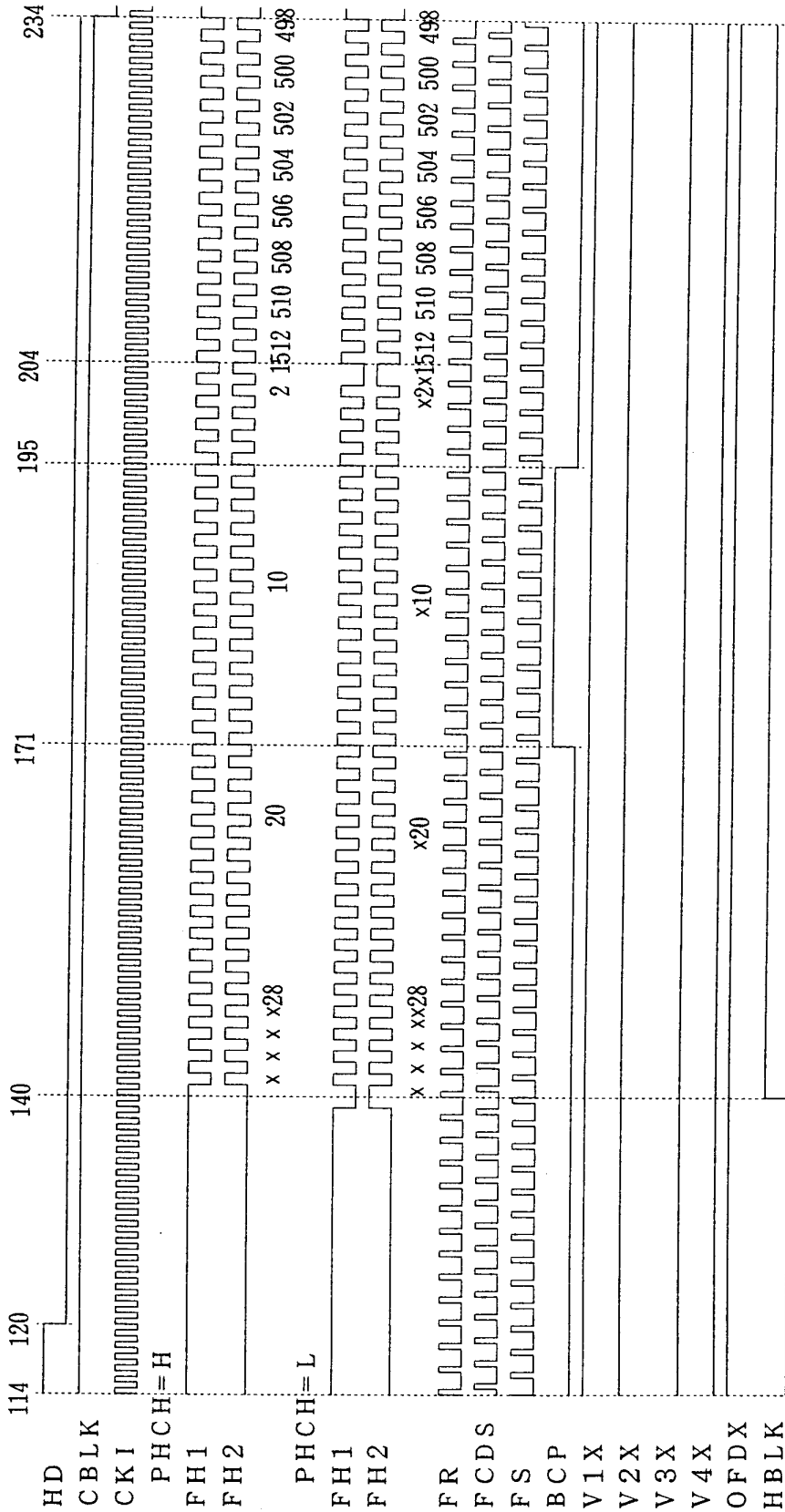

6-5. Read out pulse (1)  
 Four-power supply operation CCD [Type A, B Normal mode] The number: OSCI clock pulse 1clk=52.4ns(51.8ns), ( ) : PAL  
 ODD (1st/3rd) Field

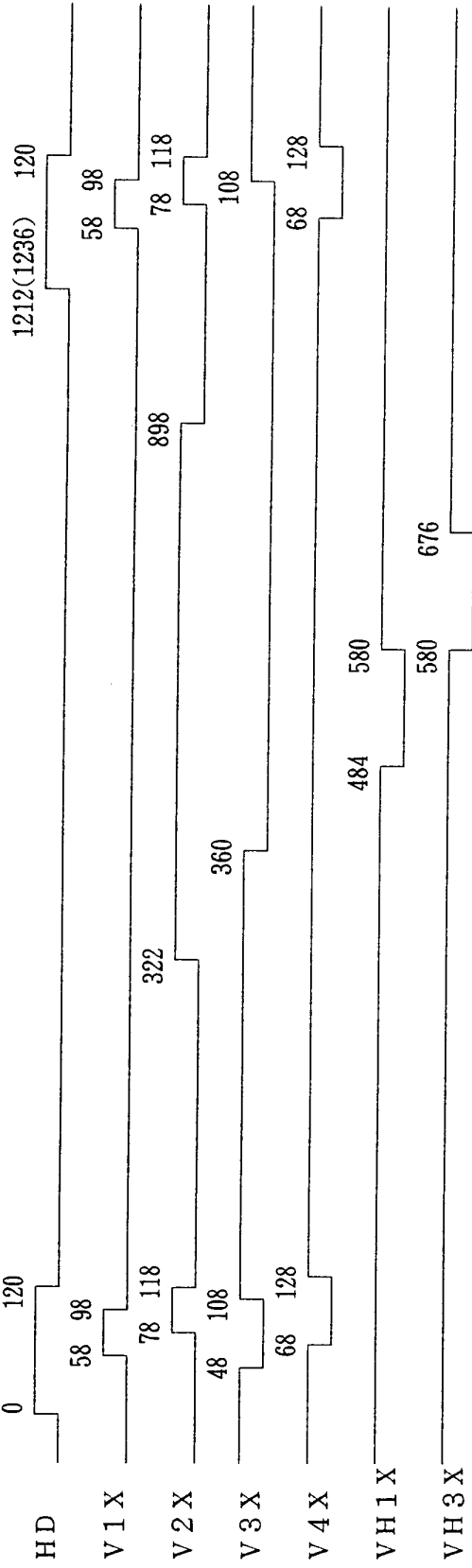

EVEN (2nd/4th) Field

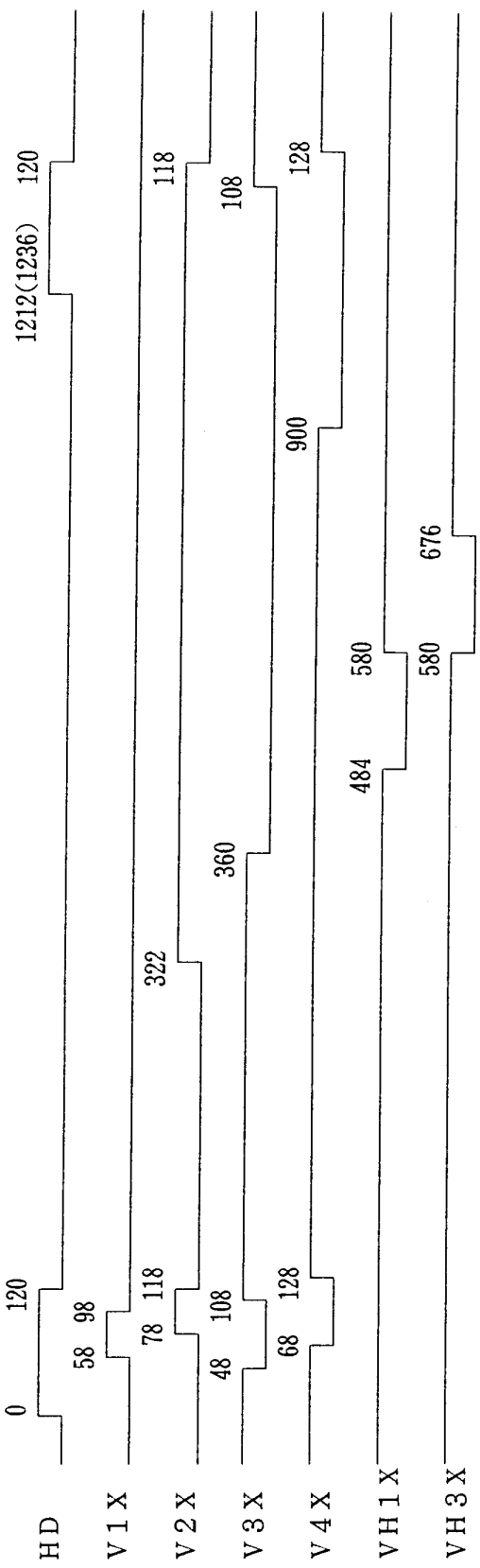

Read out pulse (2)  
 Four-power supply operation CCD [Type A Mirror mode]  
 ODD (1st/3rd) Field      The number: OSCI clock pulse    1clk=52.4ns(51.8ns),    ( ) : PAL

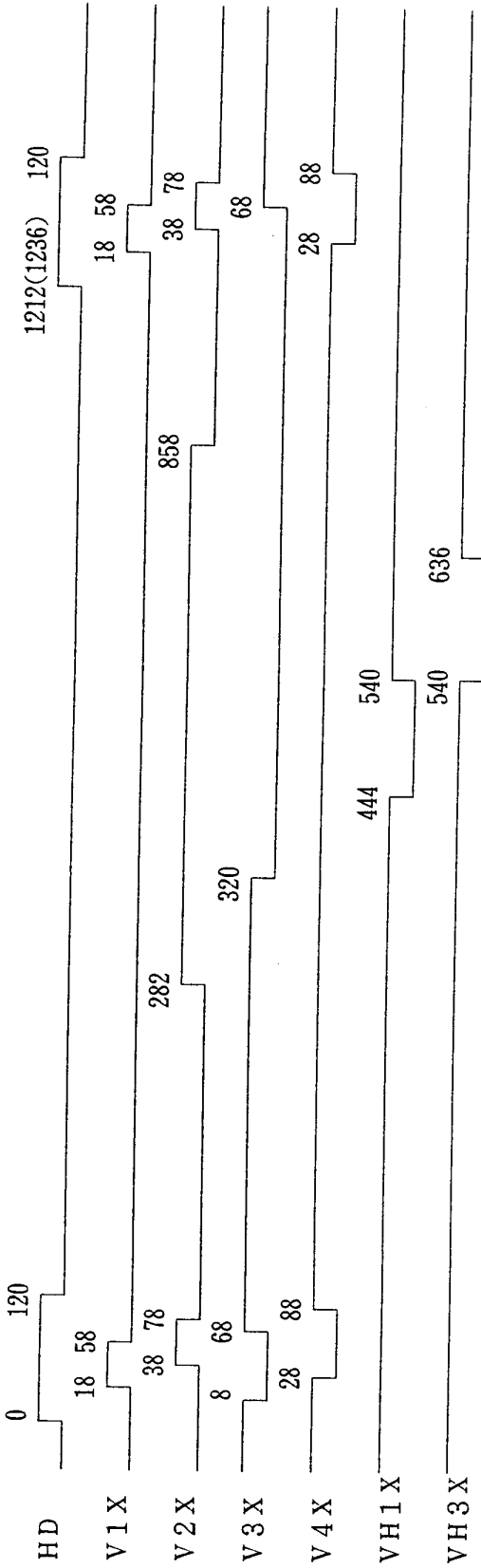

EVEN (2nd/4th) Field

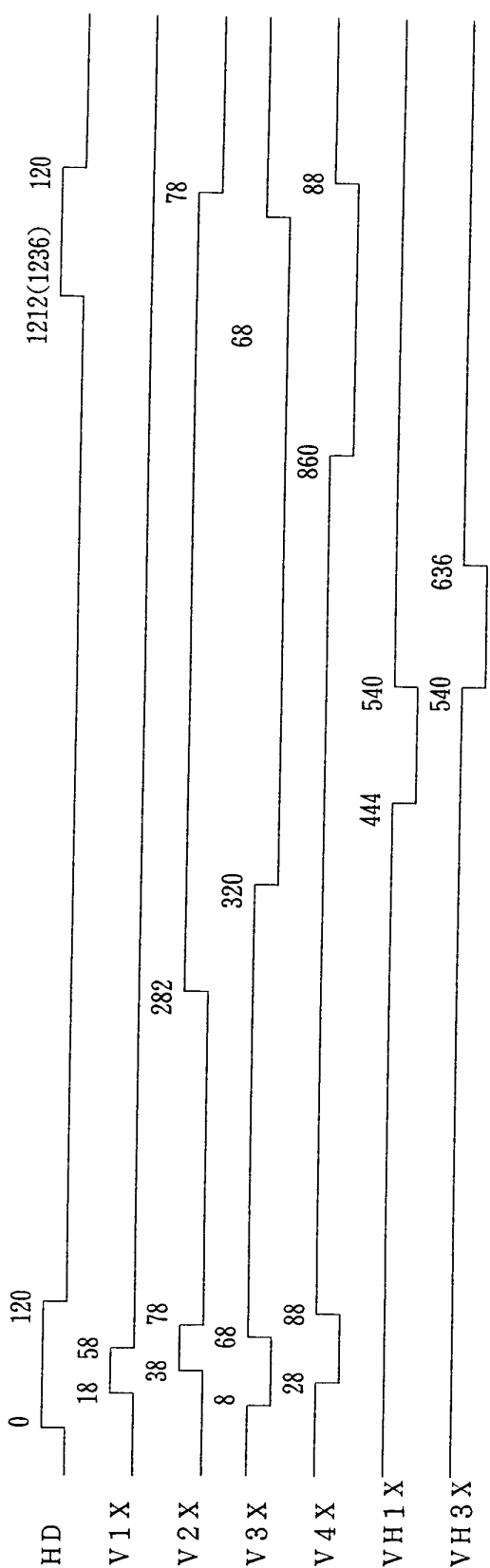

LZ9GG33M

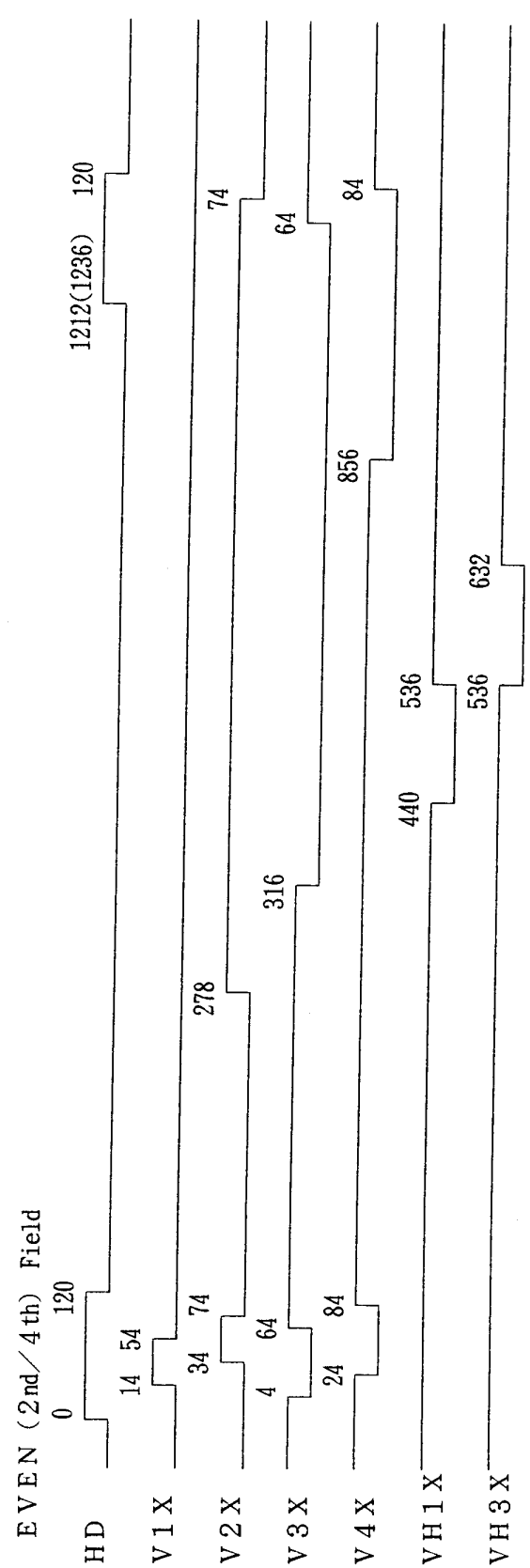
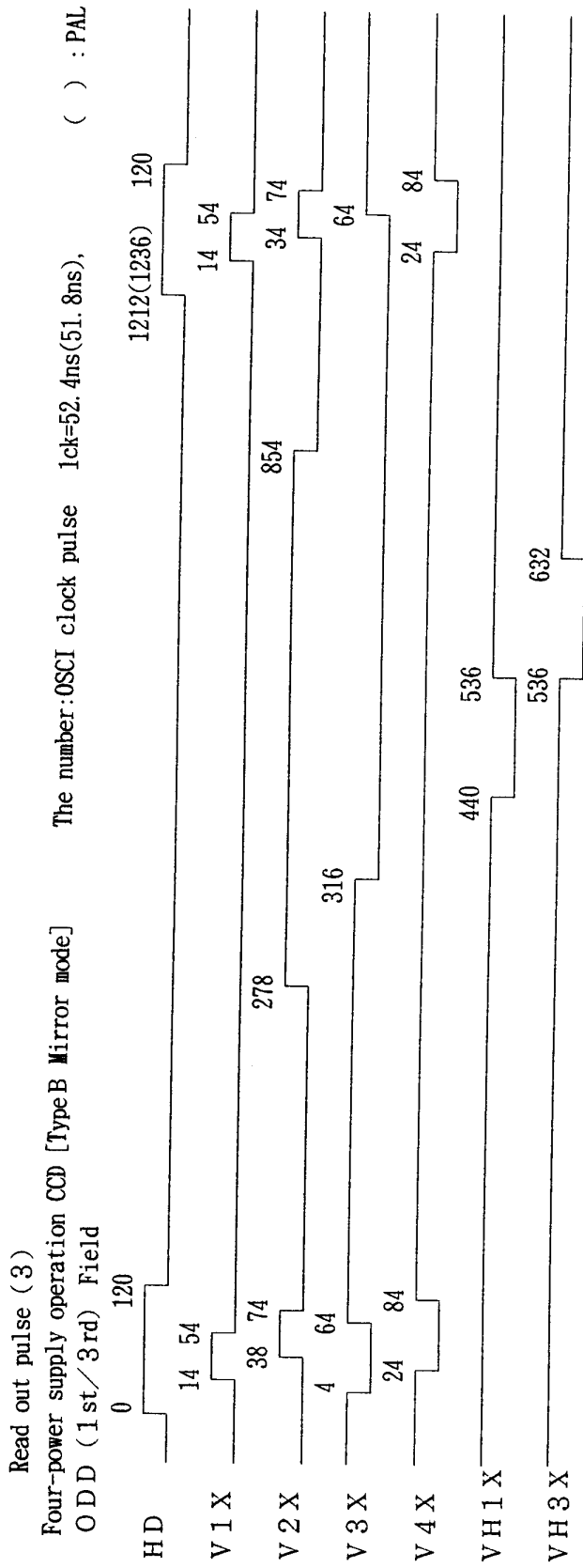

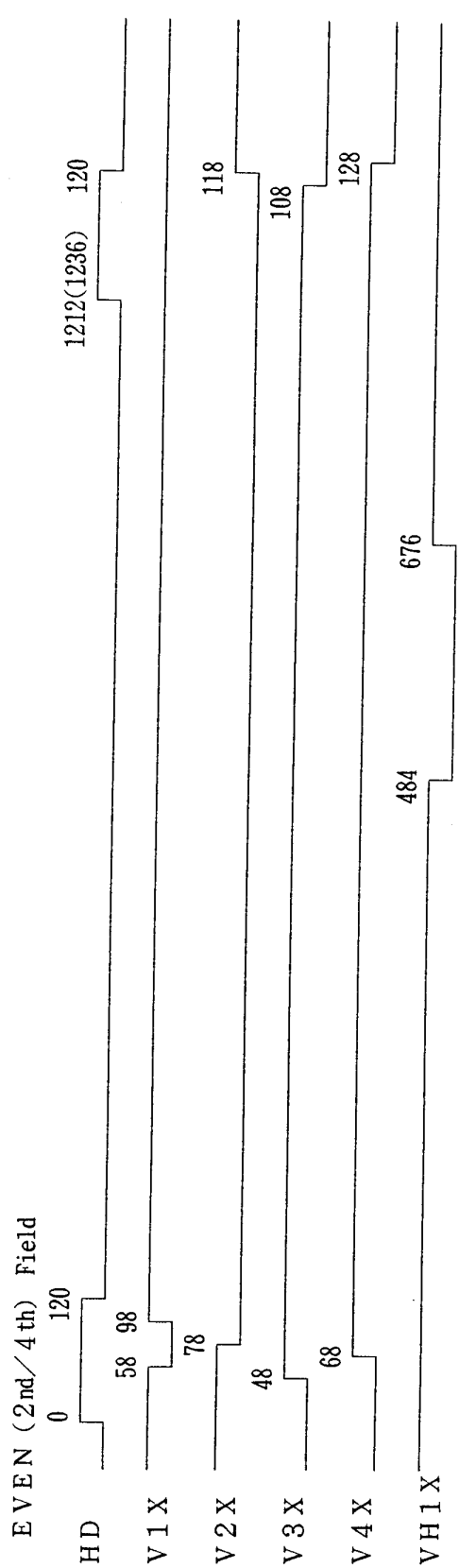
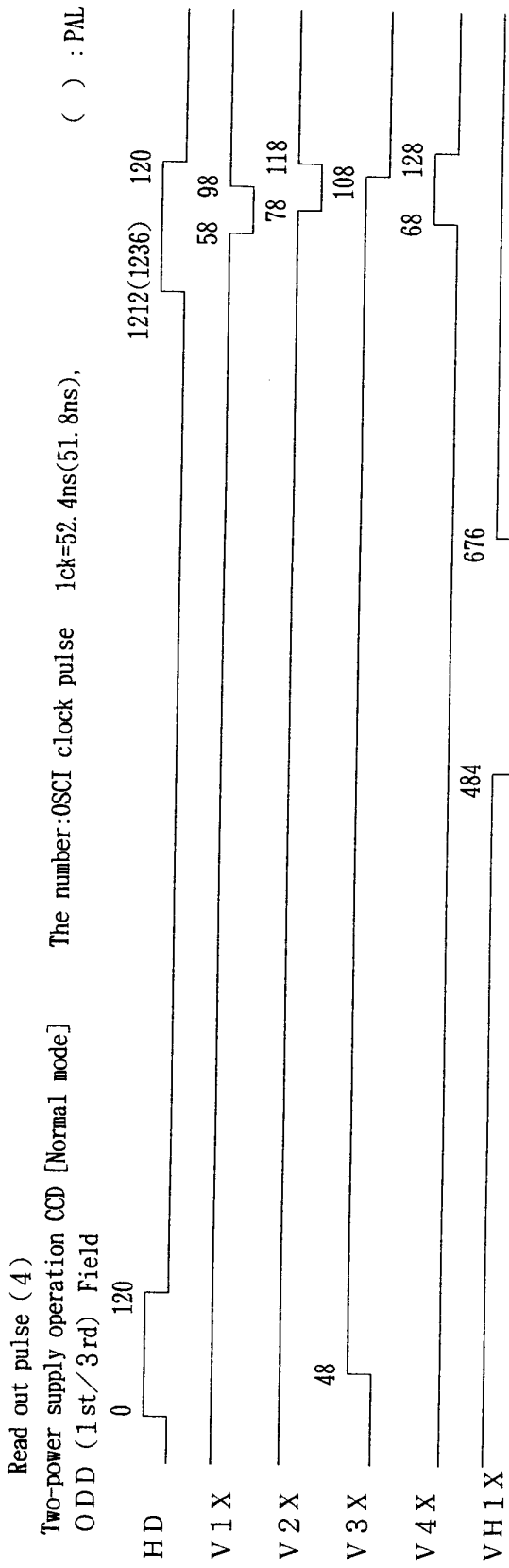



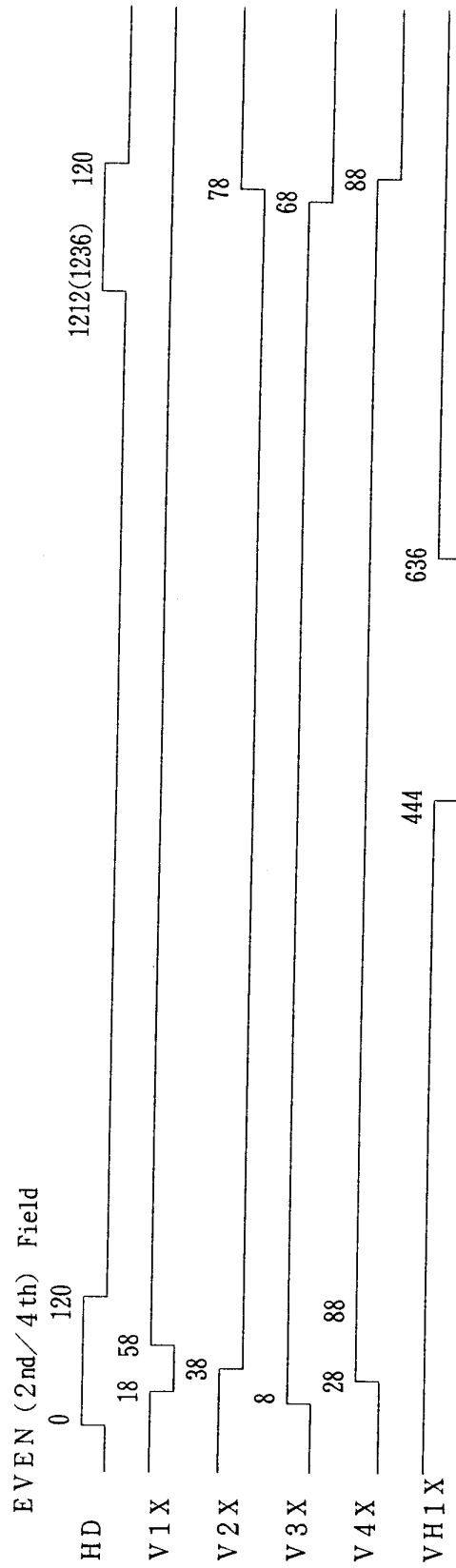
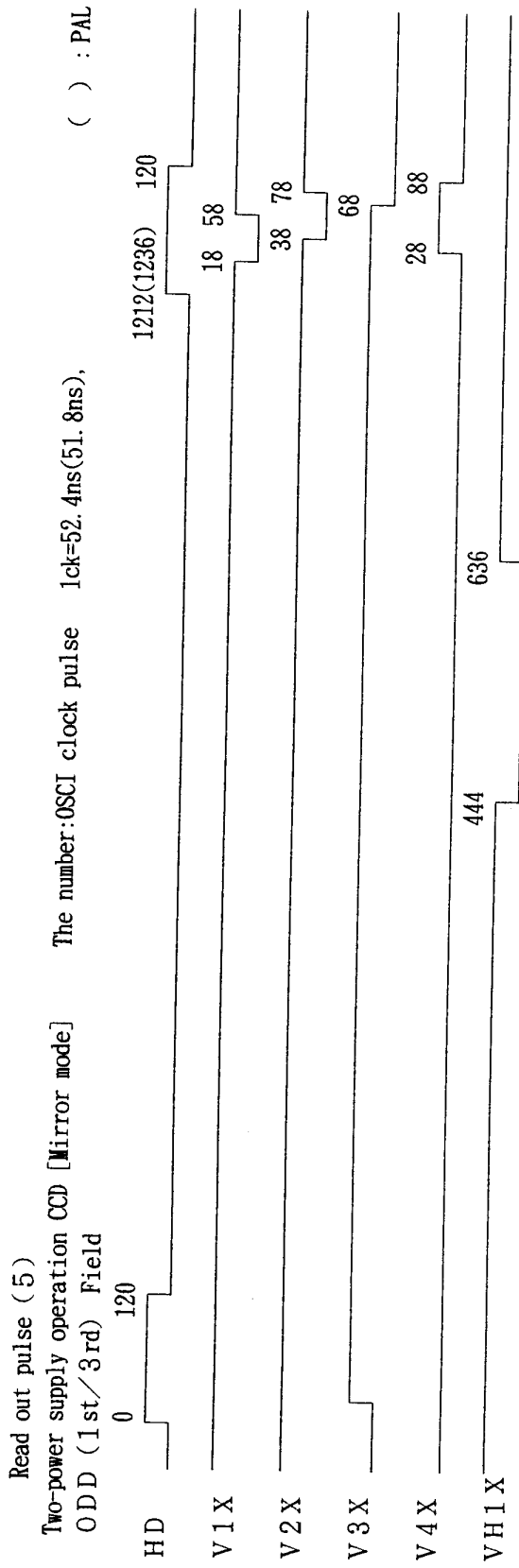

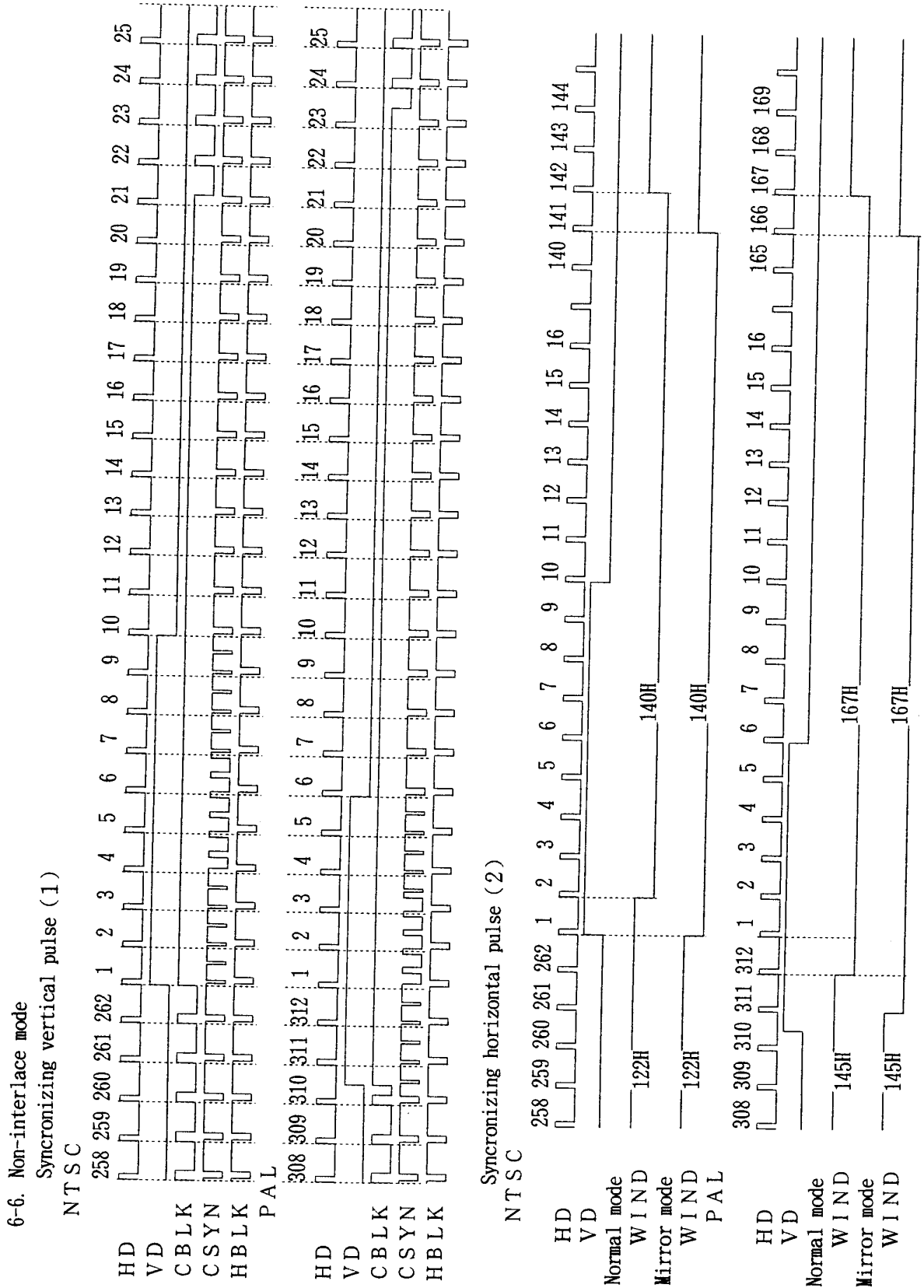

Vertical pulse for driving CCD (1) NTSC-1

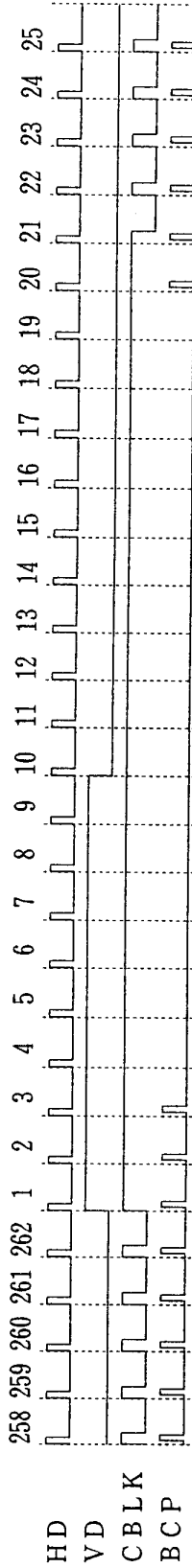

[Four-power supply operation CCD (CCD 2 = L)]

[Normal mode (MIR=L)]

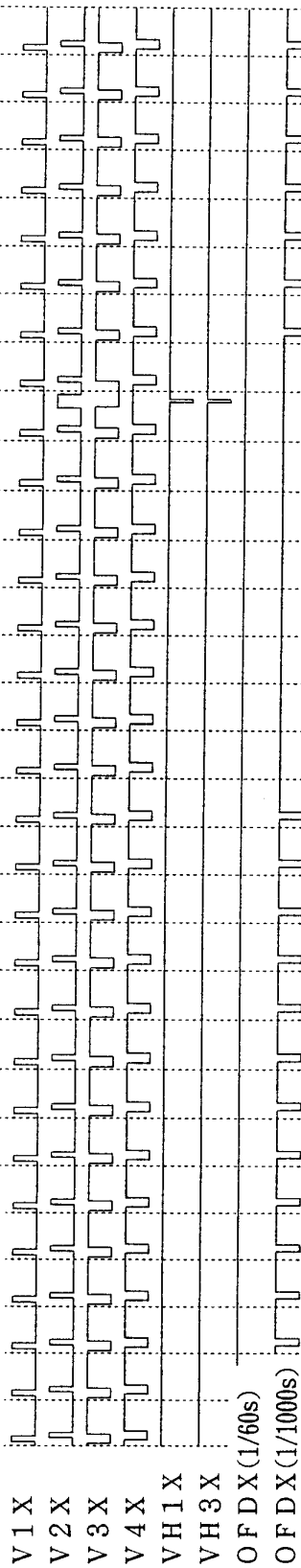

[Mirror mode (MIR=H)]

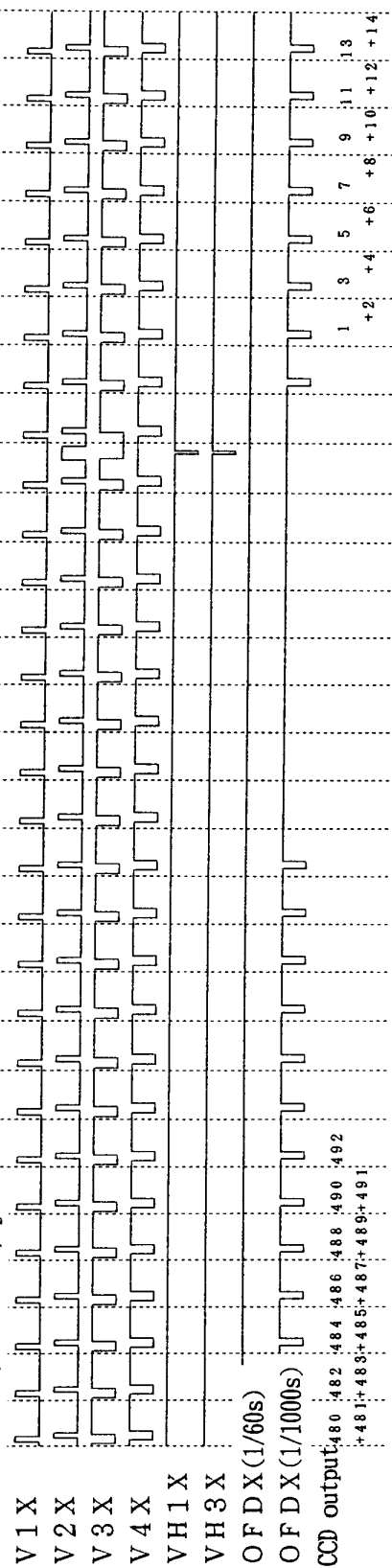

CCD output: 480 : 482 : 484 : 486 : 488 : 490 : 492  
 + 481 : + 483 : + 485 : + 487 : + 489 : + 491

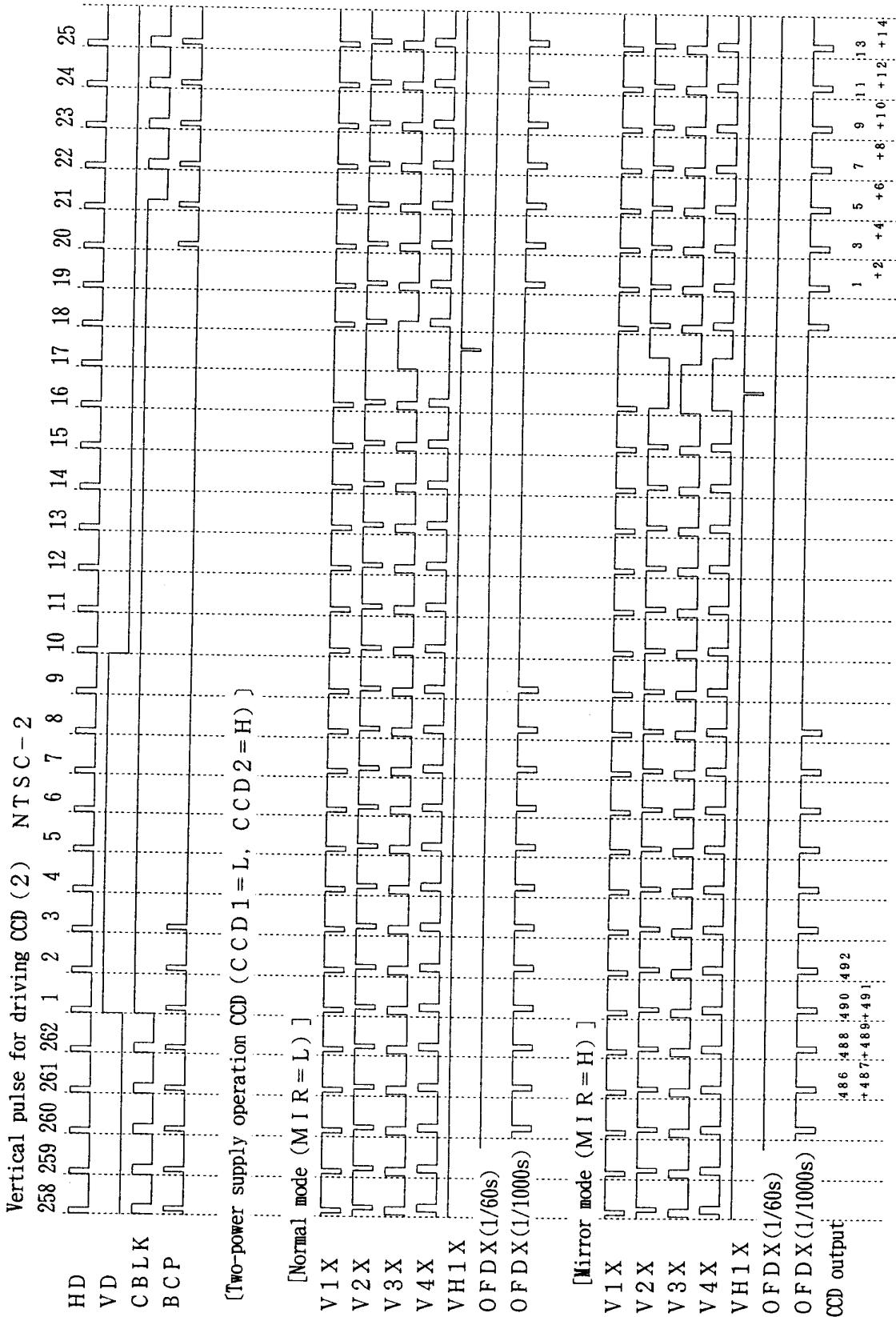

LZ9GG33M

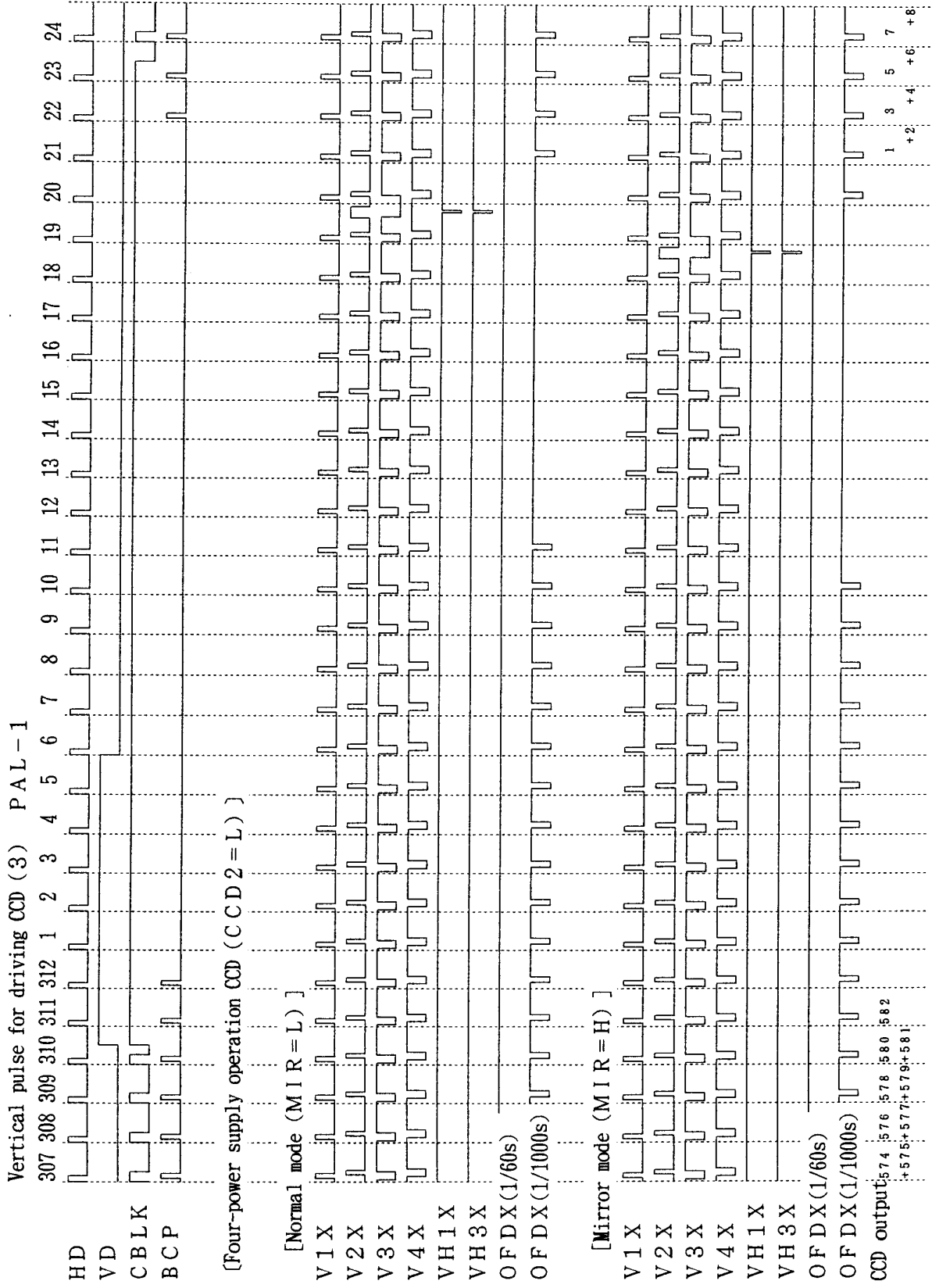

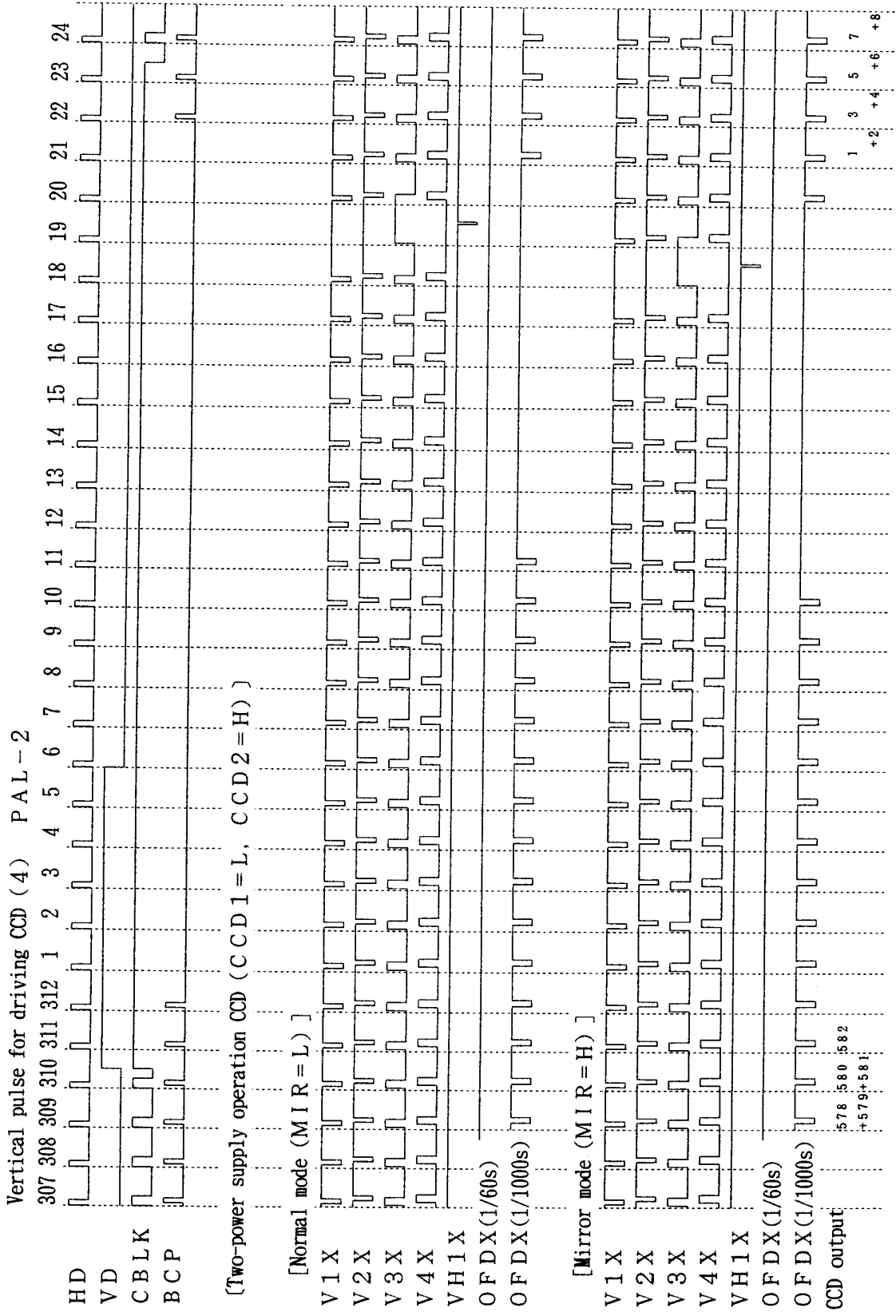

7 Package and packing specification

1. Package Outline Specification

Refer to drawing No. AA 1 0 3 5

2. Markings

2-1. Marking contents

(1) Product name : LZ9GG33M

(2) Company name : SHARP

(3) Date code

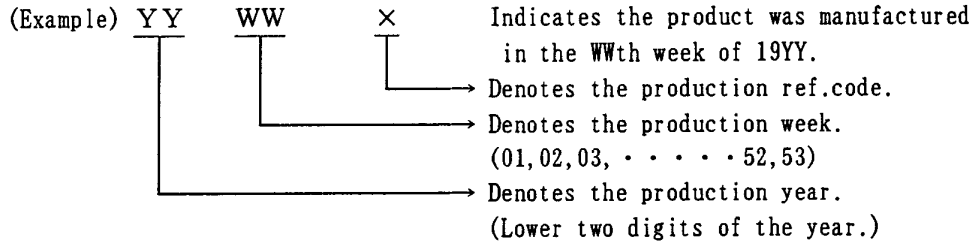

(4) The marking of "JAPAN" indicates the country of origin.

2-2. Marking layout

Refer to drawing No. AA 1 0 3 5

(This layout do not define the dimensions of marking character and marking position.)

3. Packing Specification

3-1. Packing materials

Material Name	Material Specification	Purpose
Tray	Conductive plastic (80devices/tray)	Fixing of device
Upper cover tray	Conductive plastic (1tray/case)	Fixing of device
Laminated aluminum bag	Aluminum polyethylene (1bag/case)	Drying of device
Desiccant	Silica gel	Drying of device
P P band	polypropylene (3 pcs/case)	Device tray fixing
Inner case	Card board (800devices/case)	Packaging of device
Label	Paper	Indicates part number, quantity and date of manufacture
Outer case	Cardboard	Outer packing of device case

(Devices shall be placed into a tray in the same direction.)

3-2. Outline dimension of tray

Refer to attached drawing

4. Precaution For Unpacking

- (1) Unpacking should be done on the stand as well as human body treated with anti-ESD.
- (2) Conductive treatment or anti-ESD treatment is given to a tray. Use the equivalent tray, if it is changed to another one.

### 5. Surface Mount Conditions

Please perform the following conditions when mounting ICs not to deteriorate IC quality.

#### 5-1. Soldering conditions (The following conditions are valid only for one time soldering.)

Mounting Method	Temperature and Duration	Measurement Point
Reflow soldering (air)	Peak temperature of 240°C, duration less than 15 seconds above 230°C, temperature increase rate of 1~4°C/second	IC surface
Vapor phase soldering	215°C or less, duration less than 40 seconds above 200°C	Steam
Manual soldering (soldering iron)	260°C or less, duration less than 10 seconds	IC outer lead surface

#### 5-2. Conditions for removal of residual flux

- (1) Ultrasonic washing power : 25 Watts/liter or less
- (2) Washing time : Total 1 minute maximum
- (3) Solvent temperature : 15~40°C



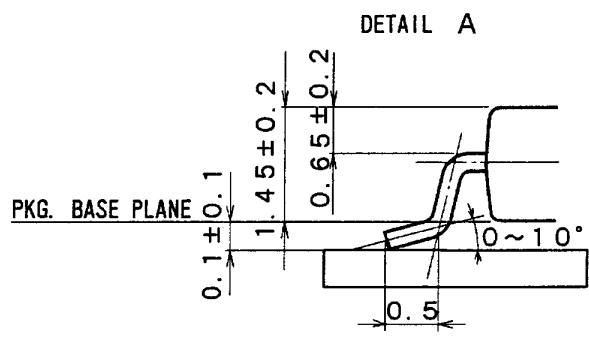
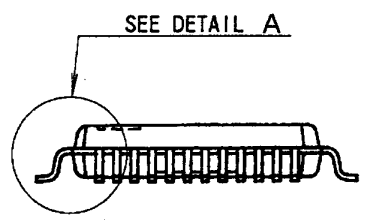
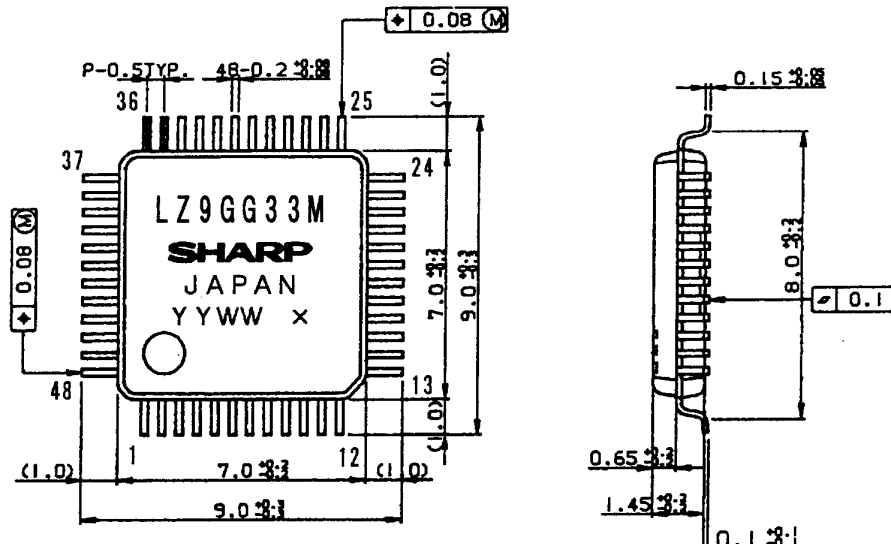

名称	リード仕上	TIN-LEAD	備考
NAME	LEAD FINISH	PLATING	
DRAWING NO.	単位	UNIT	プラスチックパッケージ外形寸法は、バリを含まないものとする。 Plastic body dimensions do not include burr of resin.
AA1035	mm	mm	

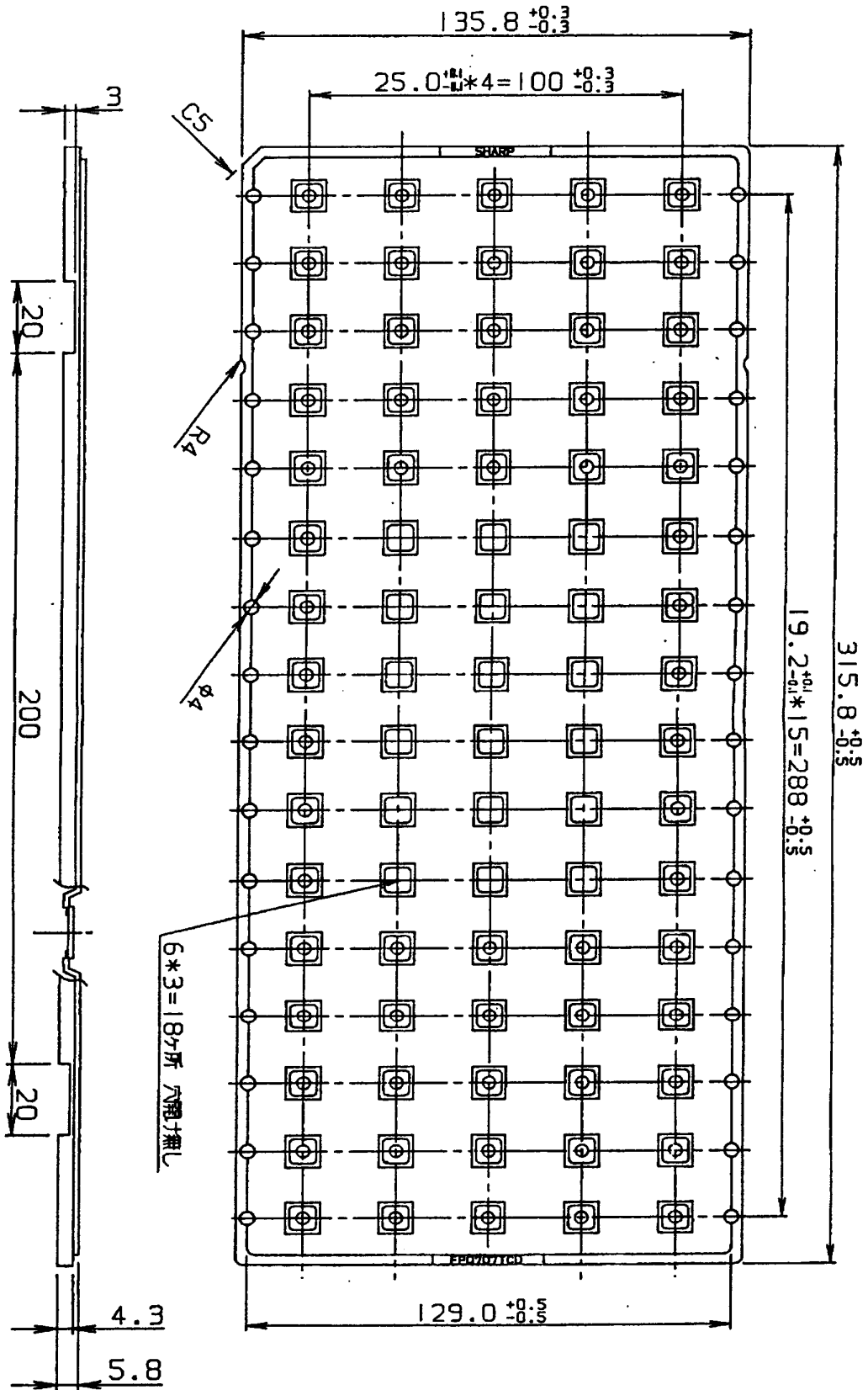

名称 NAME	FP0707TCD		備考 NOTE
DRAWING NO.	CV536	单位 UNIT	mm